

This work was supported by the US Department of Energy, Office of Nuclear Safety, Division of Nuclear Facility Safety.

DISCLAIMER

This report was prepared as an account of work sponsored by an agency of the United States Government. Neither the United States Government nor any agency thereof, nor any of their employees, makes any warranty, express or implied, or assumes any legal liability or responsibility for the accuracy, completeness, or usefulness of any information, apparatus, product, or process disclosed, or represents that its use would not infringe privately owned rights. References herein to any specific commercial product, process, or service by trade name, trademark, manufacturer, or otherwise, does not necessarily constitute or imply its endorsement, recommendation, or favoring by the United States Government or any agency thereof. The views and opinions of authors expressed herein do not necessarily state or reflect those of the United States Government or any agency thereof.

LA-9624-M
Manual

UC-32
Issued: January 1983

EVENT User's Manual

A Computer Code for Analyzing Explosion-Induced Gas-Dynamic Transients in Flow Networks

P. K. Tang 3563 536.6 9553
R. W. Andrae
J. W. Bolstad 6067
W. S. Gregory 6231



Los Alamos Los Alamos National Laboratory
Los Alamos, New Mexico 87545

EVENT USER'S MANUAL

A COMPUTER CODE FOR ANALYZING EXPLOSION-INDUCED GAS-DYNAMIC TRANSIENTS IN FLOW NETWORKS

by

P. K. Tang, R. W. Andrae, J. W. Bolstad, and W. S. Gregory

ABSTRACT

This report contains supporting information for the computer code EVENT, which can predict explosion-induced gas-dynamic transients in flow networks. The code is capable of analyzing transients in any arbitrarily designated interconnections in a network of building rooms and ventilation systems. The EVENT code is designed to provide improved methods of safety analysis for the nuclear, chemical, and mining industries. A lumped-parameter formulation is used. This version of the EVENT code is particularly suitable for calculating the detailed effects of explosions in the far field using a parametric representation of the explosive event. The input for the code and a sample problem that illustrates the code's capabilities are provided.

I. INTRODUCTION

This report contains information supporting the computer code EVENT, which can predict explosion-induced gas-dynamic transients within structures. The code is directed toward nuclear, chemical, and mining facilities and the primary release pathway--the ventilation system. However, the code is applicable to other structures and can be used to model other airflow pathways. This code is the first of a number of versions that will evolve into more refined and improved codes with greater capability. It is designed to provide improved safety analysis methods for industry.

EVENT models steady-state and transient gas-dynamic conditions in complex airflow pathways within structures. System flow parameters in this version of the code are based on the following assumptions.

- o Lumped-parameter formulation
- o Perfect gas (air)
- o Compressible
- o Momentum balance with friction and inertia for ducts
- o Choking
- o Blower characteristics
- o Linear and nonlinear filters
- o Mass and energy addition to the gas phase

A problem can be stopped and restarted. This is especially advantageous when modeling systems with changing time steps or analyzing complex systems requiring long computing times. This report contains a detailed description of the modeling necessary to simulate the facility system and the explosive event.

II. THE COMPUTER CODE

EVENT is written in FORTRAN IV and is designed to be used on large computers. The program is portable; that is, it should be installed easily on most computers with a minimum of changes. Four ASCII and three binary files are used.

- o Input (unit 5)
- o Standard printed output (unit 6)
- o Output for restart (unit 18)
- o Temporary read-write (units 59 and 17)
- o Output for CRT plot (unit 10)
- o Saved output (unit 13)

Plotting on a TEKTRONIX or its equivalent can be done using an auxiliary program based on the DISSPLA software (input unit 10). Standard printed plots and the unit 10 file also can be made from the information on unit 13 after the run is completed.

EVENT was developed to be run on the Control Data Corporation CDC 7600 computer, but it is intended to run on most computers with minimal modifications. The execution size of EVENT is approximately 32 k decimal words on the 7600. If the word length of the computer being used is less than that of the 7600, namely 60, double precision in the solution portion may be needed to retain the same level of accuracy. The current input parameter limits defining the maximum problem size are listed in Table I.

TABLE I
MAXIMUM PROBLEM SIZE

<u>System Parameters</u>	<u>Maximum Number</u>
Branches	200
Nodes	210
Volumes	200
Boundary nodes	10
Time functions for each type	5
Points per time function	100
Blower functions	20
Points per blower function	20
Filter functions	50
Points per plot	101
Plots per frame	4
Frames	25

EVENT can be modified readily to increase or decrease the storage space allocated to the parameters shown in Table I. Information is given at the end of the code that will make it easy for a programmer to modify the code. This includes an index of subroutines, a summary of read-in statements, and a glossary of variables. The EVENT computer code is available to the public, and copies of the source deck can be obtained from the National Energy Software Center at Argonne National Laboratory.

III. MODELING

A. General

EVENT is designed to predict airflows in an arbitrarily connected network system. For example, in a nuclear facility, the network system could include process cells, canyons, laboratories, offices, corridors, and offgas systems. In addition, the ventilation system is an integral part of this network. The ventilation system is used to supply air into, through, and out of the facility. Therefore, EVENT must be capable of predicting flow through a network system that includes ventilation system components such as filters, dampers, ducts,

and blowers. These ventilation system components are connected to the rooms and corridors of the facility to form a complete network for moving air through the structure and perhaps to maintain pressure levels in certain areas.

B. System Modeling

The first and most critical step in setting up a model of the air pathways in a nuclear facility requires a comprehensive schematic showing the system components and their interconnections. Drawings, specifications, material lists, safety analysis reports, and existing schematics can be used to derive a system description. A physical inspection of the facility and consultations with the designer(s) before and after the schematic is drawn may be necessary to verify that it is correct. The user frequently encounters a lack of data at this stage. Although there is no substitute for accurate data, certain assumptions, averaging, or conservative estimates can be used to make the problem manageable. Figures 1 and 2 show how a simple ventilation system within a facility structure can be transformed into a network schematic. We will illustrate the system modeling concepts in the next section and then provide additional details for the gas-dynamic modeling.

1. System Definitions. Three terms are used to describe the construction of a model and are used extensively in the remainder of this report.

- o System - network of components (branches) joined together at places called nodes.

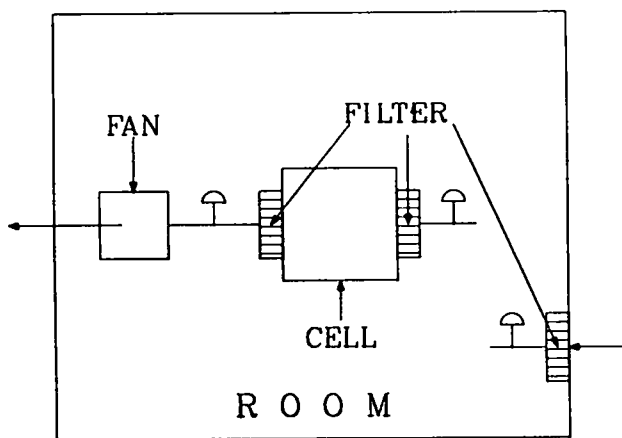

Fig. 1.

Facility with simple ventilation system.

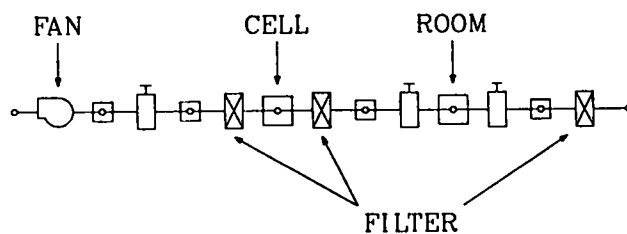

Fig. 2.

Ventilation network schematic.

o Branch - a connecting member between upstream and downstream nodal locations. A branch contains one component, such as a duct, valve, damper, filter, or blower. Gas flows and pressure differentials are associated with branches.

o Node - connection point or junction for one or more branches. Volume elements such as rooms, gloveboxes, and plenums contain capacitance. Even a long duct or flow pathway is divided into a series of volume nodes. Compressibility of the system fluid is accounted for at these capacitance nodes. Boundary points also are defined as nodes, and gas pressure, density, and temperature are specified at nodes. In the EVENT code, all nodes contain finite volumes except the boundary nodes.

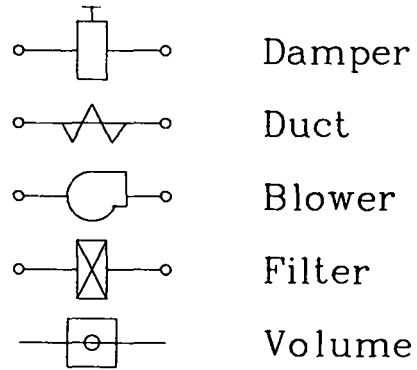

Fig. 3. Network building blocks.

2. System Modeling Examples. Network systems for airflow through a facility can be constructed using a building-block approach. The building blocks used to construct network systems are shown in Fig. 3. These building blocks can be arranged as shown in Fig. 4 to form any arbitrary system, and these symbols will be used throughout this manual. Figure 5 is an example of the correspondence of the building-block schematic with a different simple network system.

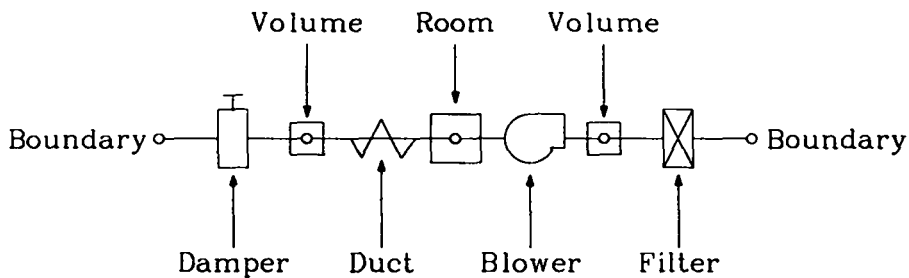

Fig. 4. Connection of building blocks.

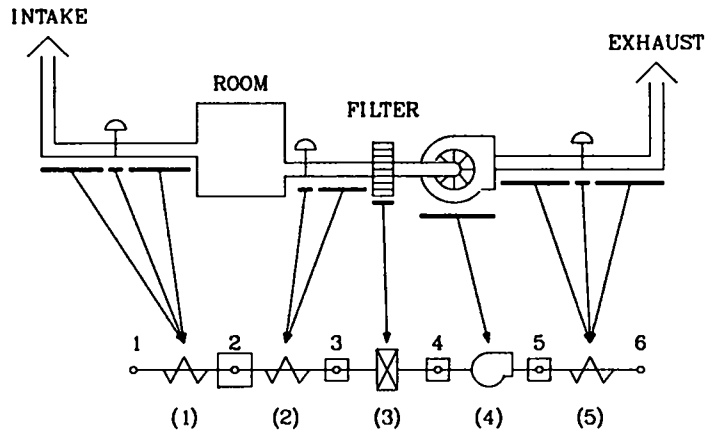

Fig. 5.
Lumped modeling of a simple system.

Nodes 1 and 6 in Fig. 5 are boundary nodes. A capacitance node (2) represents the sampling room. In Fig. 5, branches are shown at the tips of arrows. The branch numbers are in parentheses adjacent to their corresponding branches. Note that branch 3 is connected on the upstream side by node 3 and on the downstream side by node 4. Duct resistance is lumped or combined with damper resistance for branches 1, 2, and 5. The duct capacitance is specified by the volume nodes 3, 4, and 5; thus, all internal nodes should have capacitance.

The network model is shown without lumping the duct and damper in Fig. 6. This is a more detailed representation of the system and will yield more information on spatial distribution.

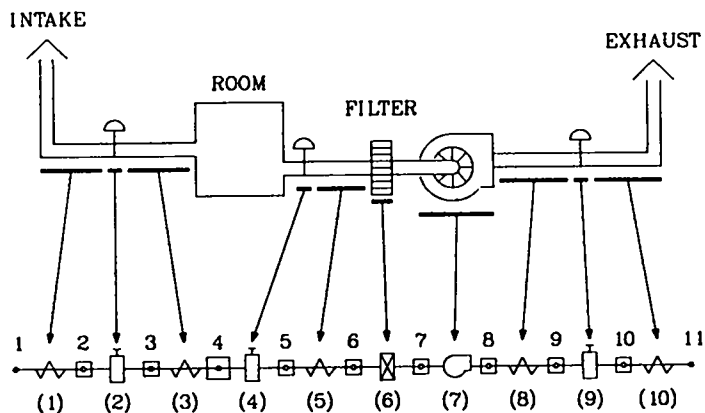

Fig. 6.
A detailed modeling of the simple system.

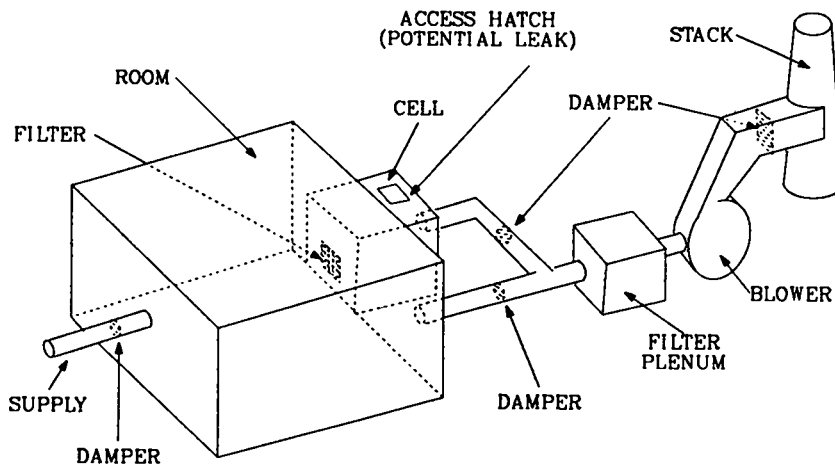

Fig. 7.
A complex system.

Thus far, we have illustrated an extremely simple network system. A slightly more complex system is shown in Fig. 7, and the corresponding schematic is shown in Fig. 8. This system illustrates a room (node 2) with three connecting branches (1, 2, and 3). The leakage path around the cell access hatch is illustrated using branch 5 and node 5.

C. Gas-Dynamic Models

EVENT can handle severe gas-dynamic transients inside a flow network; the theoretical detail is presented in Ref. 1. Some governing equations are presented in Appendix A, but we will summarize only the gas-dynamic features of the code here.

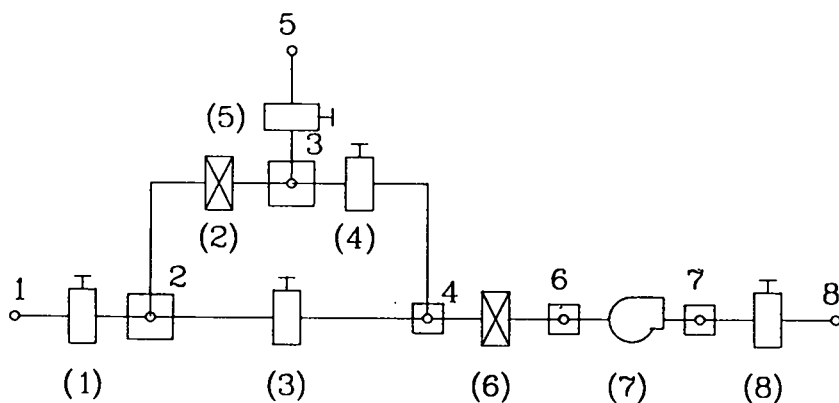

Fig. 8.
Model schematic of a complex system.

A flow network is assumed to consist of two major components, nodes and branches. A node can be either a boundary where the atmospheric condition is usually assumed or a volume where the conservation of mass and energy applies. Branches connect any two nodes and are usually ducts, filters, or blowers. A momentum equation that includes the effect of wall friction and inertia is used to relate the flow rate to the pressure drop across a duct; choking is imposed on the duct flow if the condition warrants. A filter provides only resistance to the flow; both linear and quadratic dependences of pressure on the flow rate are included. Finally, a quasi-steady relation is imposed between the pressure head and the flow rate for the blower. This lumped-parameter approach to the description of the system ignores the detailed spatial variation of the flow properties.

We have stated already that the gas-dynamic and thermodynamic conservation laws are applied to the system. We assume further that only air is present and it follows ideal gas laws. Finally, an explosion is simulated by high-energy air injection to the system or its equivalent. The characteristics of each component will be discussed separately.

1. Ducts. Ducts are modeled using the momentum equation with inertia and wall friction to describe their branch properties; a choking condition will replace the momentum relation if the flow velocity is high.

EVENT can calculate the resistance coefficients of ducts for initially given values of pressure drop and flow. A user-supplied resistance overrides the calculated value and is particularly useful in parametric and sensitivity studies. Other parameters such as duct length and flow cross-section area must be prescribed as well. An important feature in modeling ducts with EVENT is that the duct also should be treated as a series of volume nodes and branches. This representation is necessary for a duct because the volume is not zero.

2. Dampers and Valves. The treatment of dampers is similar to that of ducts except that the length need not be specified. The effective resistance coefficient is prescribed or calculated similar to the one used for ducts. Thus, the damper or valve losses may be lumped freely with duct losses.

3. Filters. The filters are considered generally to be linear elements. The filter resistance coefficients can be obtained from the manufacturer, or

the code will calculate a resistance coefficient for an initially given pressure drop and flow rate if desired.

Based on empirical evidence, the filter is not a linear element at high flow rates. The pressure drop across a filter contains the summation of linear and quadratic relations on flow rate. The EVENT code contains these new features, but the option of using the quadratic portion requires additional input for the dissipation of turbulence. This is done by the filter function card specification.

4. Blowers and Fans. A representative blower curve under quasi-steady conditions is shown in Fig. 9. The curve is based on actual experimental results, including backflow and outrunning flow. The manufacturer's literature usually supplies only the first-quadrant information. The blower is placed in a branch, as are filters, dampers, and ducts. It is considered an active element in the system because it supplies energy to the system.

The EVENT code requires the relation between pressure head and volume flow to be segmented (Fig. 10). A negative slope must be maintained throughout. The usefulness of this quasi-steady approach is uncertain under an explosive stress condition. More analytical and experimental work will be carried out in this area.

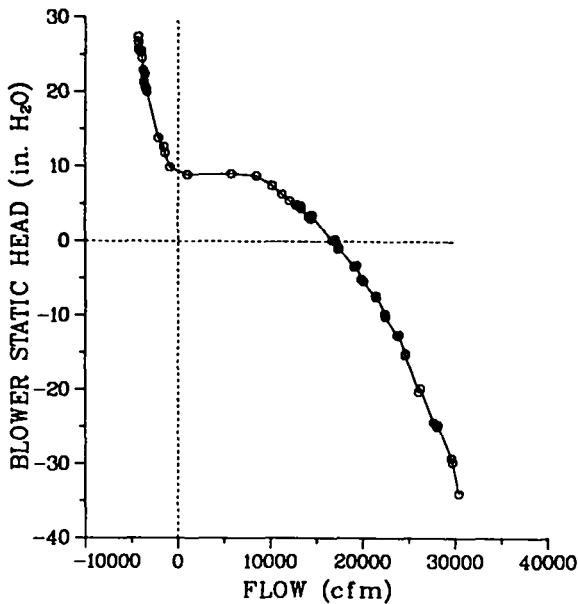

Fig. 9.
Blower quasi-steady characteristic curve.

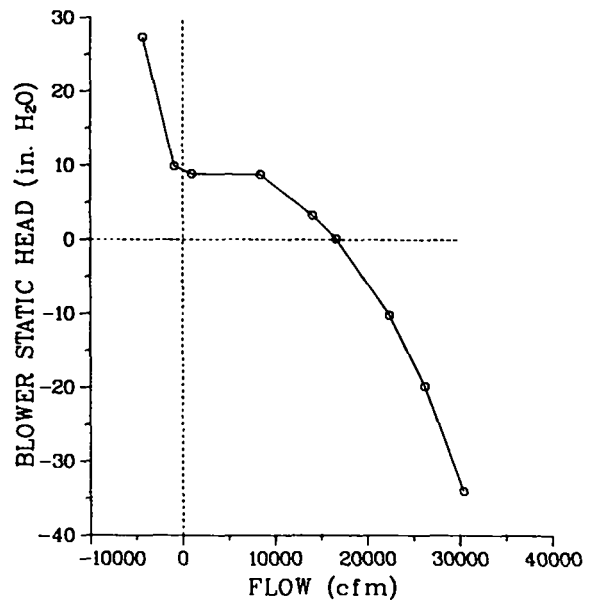

Fig. 10.
Blower curve used in EVENT.

5. Rooms, Cells, and Plenums. Rooms, cells, and containment volumes are specified at nodal points. The capacitance coefficient is the room volume calculated from architectural and construction drawings. A room acts as an accumulator and provides mass and energy storage for the gas. Manifolds and returns also may have sufficient volume to form a capacitance node. This is indicated by a message when EVENT finds that the duct volume is greater than half the volume of the smallest room. An average cross-sectional area also can be specified by the user so that velocities through rooms can be calculated. Otherwise, the area is assumed to have a very large value.

The capacitance of ducts is not included automatically even when duct dimensions are specified; capacitance is specified only through volume nodes. Therefore, the capacitance of a duct must be described that way.

6. Boundary Nodes. Any atmospheric region that has supply or exhaust openings to the ventilation system of a facility is considered a boundary node. This node can be held at a constant initial pressure and temperature, or the pressure and temperature can be varied by specifying a time function, which is described in the input section. In either case, the condition is known, and the boundary node acts as a source or a sink to the rest of the system.

7. Leakage. Effective leakage can be approximated in the model by using a boundary node and a fictitious duct. The leak rate is the flow rate. One could specify a filter in the leaking branch; however, it is usually more convenient to use the default (blank) specification on the branch description because a value is assumed in this case.

D. Initial Conditions

The gas dynamics require that steady-state conditions be established in the system before initiating the transient caused by the explosion. However, we can use the restart feature to avoid the steady-state calculation.

We caution the user about the initial condition. Most users will use the information in the flow diagram for pressures and volume flows. Quite often, the system is assumed to be in perfect balance if the volume flows match under steady-state conditions. However, the principle of fluid mechanics requires mass flow balance to achieve a steady-state pattern. Except when density is constant, volume flow balance does not imply mass flow balance. In a

ventilation system, the pressure and temperature are not constant throughout because of resistances, blower heads, heating, and cooling. Consequently, the density cannot be considered constant in general even at steady state. Users should not be surprised to find out that the steady-state result might differ from the input condition (most likely a small deviation). The input flow parameters, such as pressures, temperatures, and volume flows, are used mainly to initiate the calculation; conservation of mass and energy should lead to the final result even for steady-state calculations.

E. Explosion Description

In this code, the explosive event requires some form of simulation where the detail of the event is not significant. Basically, an explosion can be defined by a rapid pressure rise, often along with a rapid temperature rise. These pressure and temperature increases can result from physical, chemical, or even nuclear processes; for example, the rupture of a highly pressurized vessel (physical), the combustion or detonation of explosive materials (chemical), or the criticality excursion of fissionable nuclear materials (nuclear) can cause a rapid pressure rise with or without a corresponding rapid temperature rise. All these processes involve a rapid mass and energy addition to a system, whether it is closed or open. Analyses of explosions with rapid mass and energy additions are common and give good results if sufficient rate information is available. These approaches are useful for simulating an explosion inside a system and need detailed mass and energy source terms in the mass and energy equations. When the energy release rate is not known, we can use other information, such as pressure- or temperature-time histories at a particular location in combination with mass addition information; a combination of pressure- and temperature-time profiles also is acceptable. The last two approaches require experimental data on the system that can be difficult to obtain. For an explosion outside a system, the pressure and temperature-time histories at boundaries can provide information needed to investigate a system response.

F. Expected Results

The expected results are gas-dynamic parameters at different locations and times. Pressures and temperatures are calculated at nodal points; volume flows, mass flows, and pressure differentials are calculated in branches. A complete table of pressures, temperatures, and volume and mass flows always is given for

the first and last calculation time step. These archival data also include pressure differentials and volume flows according to branch elements. Up to three special output times can be requested during the run. Extreme values such as pressure, temperature, volume flow, and mass flow are listed at these special times. Also included are the extreme values of pressure differentials and volume flows according to branch elements. Finally, the extreme values of the complete problem are tabulated. Pressures, temperatures, mass and volume flows, and pressure differentials are available in time plots if they are requested.

IV. INPUT PREPARATION

A. Data Deck Organization

Table II shows the input deck organization, which must be followed. Cards labeled in capital letters contain essential solution parameters that must be evaluated; cards labeled "Data Separator" simply separate the input data and provide an opportunity to insert comments; they are ignored in the solution to avoid an early computer abort but must always be inserted as shown. Be sure that the number of data cards specified on the control card agrees with the amount of data appearing in the control section. Even if time, filter, and blower functions are not to be used in our described solution, they still may appear in the input if their existence is specified. This feature provides the flexibility that is especially useful in parametric studies.

Once the EVENT model parameters have been fully evaluated, this information is placed in a file called INPUT, which becomes the input for the computer program. This file is based on fixed formats; that is, the location of card information is prescribed. The title is followed by control information and then by the data. The purposes of control information are to specify the amount of data to be read in, to prescribe solution run options, and to indicate the size of the model. Each type of information is separated from neighboring data by a separator card that is used to identify what follows. If the number of data items specified on the control cards does not agree with the number of data cards provided, the program will try to read data from an adjacent category and will probably abort with a diagnostic message because the format will not be correct.

B. Input Card Description

Input cards are described in the order they occur in the card deck. Abbreviations used under the heading "Data Type" are (a) A/N for alphanumeric data (any combination of letters and numbers), (b) FP for floating-point data, and (c) I for integer data. Alphanumeric data should be left-justified with respect to the first column of the field definition. (Data should start in the first column of the field.) Integer data should be right-justified in the data field (the last data character should appear in the right-most column of the field). For example, the integer 5 placed in column 4 of the branch description card would be interpreted as branch 50 if the field definition encompasses columns 1 through 5. Floating-point data also are right-justified. Only large or small floating-point numbers require the form +nnnE+mm, where n and m are integers. Intermediate floating-point numbers may be specified as +nn--.nnnn-- with the decimal point given or as integers with the decimal point assumed to the extreme right of the number. Values of data occurring under the heading "Default Value" are used by EVENT if the input data field is left blank.

DATA SEPARATOR CARD DESCRIPTION

Col.(s)	Data Description
1-80	These cards may be left blank or may contain alphanumeric data. The cards are used to separate different types of data cards. The contents of the card are ignored by EVENT.

TITLE CARD DESCRIPTION

Col.(s)	Data Description
1-80	Eighty columns of alphanumeric data are available to the user. These data are used for headings on output lists.

RUN CONTROL I CARD

Col.(s)	Data Description	Data Type	Default Value	Maximum Value
4-5	Run option SS - steady-state solution only ST - steady-state plus transient RS - restart problem TP - generate restart deck after transient SP - generate restart deck after steady state RP - generate restart deck after restart	A/N	ST	
6-15	Problem start time(s)	FP	0.0	
16-25	Transient time step size(s)	FP	0.01	
26-35	Total problem run time(s)	FP	1.0	
40	Number of special outputs	I	0	3
41-50	First special output time(s)	FP	0.0	
51-60	Second special output time(s)	FP	0.0	
61-70	Third special output time(s)	FP	0.0	

Transient values of pressure, temperature, mass flow, volume flow, and pressure differential are saved for listing and plotting. These values are uniformly spaced between the problem start time and the total problem time. The number of output time values saved is determined by the program. Additionally, special output times (up to three) may be requested. These special output times are not included in printer plots.

RUN CONTROL II CARD

Col.(s)	Data Description	Data Type	Default Value	Maximum Value
1-5	Maximum iterations permitted per time step. The program will abort if convergence has not been achieved for this number of iterations. Ten times this number is permitted for steady-state calculations.	I	1000	
6-15	Convergence criterion	FP	0.0001	
21-25	Relaxation parameter. A value greater than 1.0 and less than 2.0 can be specified to reduce the number of iterations per time step. This is determined through successive runs and is different for each problem.	FP	1.0	
30	Initial pressure input option. Insert the letter "P" in this column if pressures at nodal points are to be supplied by PRESSURES input.	A/N	(Blank) no input pressures supplied	
35	Initial temperature input option. Insert the letter "T" in this column if temperatures at nodal points are to be supplied by TEMPERATURES input.	A/N	(Blank) implies all ambience values	

The nodal initial pressure input option is preferred over the pressure differential for branches, as described in BRANCH DATA CARD. The use of the "P" option can detect all branch connection and resistance errors in one sweep.

PLOT CONTROL CARD

Col.(s)	Data Description	Data Type	Default Value	Maximum Value
4-5	Number of pressure plot frames	I	0	25
9-10	Number of temperature plot frames	I	0	25
14-15	Number of volume flow plot frames	I	0	25
19-20	Number of mass flow plot frames	I	0	25
24-25	Number of pressure differential plot frames	I	0	25

The total number of plot frames that can be requested is 25; therefore, the sum of pressure, temperature, volume flow, mass flow, and pressure differential frames cannot exceed 25. These entries may be left blank if printer plots are not desired.

PLOT FRAME DESCRIPTION CARD

Col.(s)	Data Description	Data Type	Default Value	Maximum Value
1-5	Total number of curves this frame	I	0	4
6-10	Node/branch number for first curve	I	0	
11-15	Node/branch number for second curve	I	0	
16-20	Node/branch number for third curve	I	0	
21-25	Node/branch number for fourth curve	I	0	

Pressures and temperatures are calculated at nodal points (nodes); volume flows, mass flows, and pressure differentials are calculated for branches. This card identifies how many and which nodes or branches are to appear as curves on the plot frame. Different types of curves cannot be mixed on the same frame. Pressure frame description cards should precede the volume flow frame description cards and so on. These cards may be omitted if plot frames are not requested on the plot control card; there is no plot for a steady-state run.

TIME FUNCTION CONTROL AND AMBIENCE DATA CARD

Col.(s)	Data Description	Data Type	Default Value	Maximum Value
5	Total number of pressure-time functions	I	0	5
10	Total number of temperature-time functions	I	0	5
15	Total number of energy-time functions	I	0	5
20	Total number of mass-time functions	I	0	5
21-30	Value of ambient pressure (psia)	FP	14.7	
31-40	Value of ambient temperature (F)	FP	60	

GEOMETRY AND COMPONENT CONTROL CARD

Col.(s)	Data Description	Data Type	Default Value	Maximum Value
1-5	Total number of branches	I		200
6-10	Total number of boundary nodes	I		10
16-20	Total number of volume nodes	I		200
21-25	Total number of blower functions	I		20
26-30	Total number of filter functions	I		50

The values of these parameters control the reading of input data and should not exceed maximum values. The numbers of branches, boundaries, and volumes also cannot be zero. The total number of nodes is calculated from the volume and boundary nodes. Any time function, blower function, and filter function can be called by more than one node or branch as specified in VOLUME or BRANCH data cards.

BRANCH DATA CARDS
(First Card)

Col.(s)	Data Description	Data Type	Default Value	Maximum Value
1-5	Branch number	I		200
6-10	Upstream node number	I		210
11-15	Downstream node number	I		210
16-25	Initial estimate of flow (cfm)	FP		
26-35	Flow area (ft ²)	FP		
36-45	Length (ft) (for duct only)	FP		
50	Component type	A/N	D	
	V Damper, valve			
	F Filter			
	B Blower			
	D Duct			
51-60	Branch pressure differential (in. w.g.)	FP	0.0	
61-63	Blank			
64-65	Blower or filter function identification number	I	0	20

BRANCH DATA CARDS
(Second Card)

Col.(s)	Data Description	Data Type	Default Value	Maximum Value
1-10	Forward resistance coefficient for branch. This value (if greater than 0) overrides that calculated from pressure differential and initial flow.	FP	calculated value	
11-20	Backward resistance coefficient for branch. This value (if greater than 0) overrides that calculated from pressure differential and initial flow.	FP	same as forward resistance	

Two cards are required for each branch. The BRANCH DESCRIPTION cards need not be ordered in the input deck (branch 10 might precede branch 5). However, the total number of sets should agree with that specified in Cols. 1--5 of the GEOMETRY AND COMPONENT CONTROL card. The initial flow and pressure differentials must be finite and are used to calculate damper, duct, or filter resistance if it is not given explicitly. The pressure differential also can be calculated from the nodal pressures if the "P" option is selected on RUN CONTROL CARD II. However, using pressure differentials requires repeated runs to detect all branch connection and resistance errors. The blower or filter function called must not be zero.

BOUNDARY DATA CARD

Col.(s)	Data Description	Data Type	Default Value	Maximum Value
1-5	Boundary node number	I	0	210
6-15	Initial value of pressure (psig)	FP	0	
16-20	Pressure-time function number	I	0	5
21-30	Initial value of temperature (F)	FP	ambient	
31-35	Temperature-time function number	I	0	5

VOLUME DATA CARDS
(First Card)

Col.(s)	Data Description	Data Type	Default Value	Maximum Value
1-5	Node number for volume	I		210
6-15	Volume (ft ³)	FP		
20	Pressure time function number	I	0	5
25	Temperature time function number	I	0	5
30	Energy addition time function number	I	0	5
35	Mass addition time function number	I	0	5
36-45	Initial value of energy rate (Btu/s)	FP	0.0	
46-55	Initial value of mass rate (lbm/s)	FP	0.0	

VOLUME DATA CARDS
(Second Card)

Col.(s)	Data Description	Data Type	Default Value	Maximum Value
1-10	Cross-section area (ft ²)	FP		

Two cards are required per volume. All nodes except boundary nodes require volume node designation. Duct volume must be treated as a series of volume nodes. The VOLUME DATA cards need not be in numerical order. The value of the volume must be finite.

TIME FUNCTION CARD

Col.(s)	Data Description	Data Type	Default Value	Maximum Value
1-5	Time function number	I		5
6-10	Number of data sets in time function definition. A data set is defined as an ordered pair of values of time and function of time.	I		100
14-15	Temperature function number (for mass injection only)	I	0	5

This card controls the reading of subsequent TIME FUNCTION DATA cards. The TIME FUNCTION card is followed by one or more TIME FUNCTION DATA cards. This set of cards may be present, but it is not required for steady-state runs. The default temperature for mass addition is absolute zero.

TIME FUNCTION DATA CARD

Col.(s)	Data Description	Data Type	Default Value	Maximum Value
1-10	Value of time(s) for first time function data set.	FP	0.0	
11-20	Value of variable for first time function data set.	FP	0.0	
21-30	Value of time for second time function data set.	FP	0.0	
31-40	Value of variable for second time function data set.	FP	0.0	
41-50	Value of time for third time function data set.	FP	0.0	
51-60	Value of variable for third time function data set.	FP	0.0	

Insert as many TIME FUNCTION DATA cards as needed to define all the data sets. The TIME FUNCTION data sets are used to define all the time-dependent user-specified data for the problem. This includes time-dependent data for both boundary nodes and volume nodes. Each type of time function must be preceded by a data separator card.

Use as many TIME FUNCTION and TIME FUNCTION DATA sets as necessary to define all the time functions required by the problem. You may include time functions that are not called for in the current run. The card sets must be in the following order.

- o Pressure (psig)
- o Temperature (F)
- o Energy rate (BTU/s)
- o Mass rate (lb/s)

The defining times must be in ascending order. The temperature associated with the mass injection is assumed to be the ambient value if no temperature function is called.

BLOWER FUNCTION CARD

Col.(s)	Data Description	Data Type	Default Value	Maximum Value
1-5	Blower function number	I	0	15
6-10	Number of sets defining this blower function. A set is defined as an ordered pair of values of flow (cfm) and head (in. water).	I	0	20

The blower function cards are ordered in the same way as time function cards--an input control card is followed by one or more data cards. One control card is required for each blower type. The order of the blower function is unimportant (3 might precede 1); however, this card is used in reading the following blower function data points and must appear just before the appropriate data card(s).

BLOWER FUNCTION DATA CARD

Col.(s)	Data Description	Data Type	Default Value	Maximum Value
1-10	Flow (cfm) for the first set	FP	0.0	
11-20	Blower head (in. water) for the first set	FP	0.0	
21-30	Flow for the second set	FP	0.0	
31-40	Blower head for the second set	FP	0.0	
41-50	Flow for the third set	FP		
51-60	Blower head for the third set	FP	0.0	

FILTER FUNCTION CARD

Col.(s)	Data Description	Data Type	Default Value	Maximum Value
1-5	Filter function number	I	0	20
6-10	Blank			
11-20	Laminar coefficient	F	calculated from initial condition	
21-30	Turbulent coefficient	F	0.0	

One FUNCTION card is needed for each filter model. This card contains the laminar and turbulent coefficients. To use this filter model, a branch must call the filter identification number in the BRANCH card.

PRESSURES CARD

Col.(s)	Data Description	Data Type	Default Value	Maximum Value
1-15	Pressure (in. w.g.) at the first node	FP	0.0	
16-30	Pressure at the second node	FP	0.0	
31-45	Pressure at the third node	FP	0.0	
46-60	Pressure at the fourth node	FP	0.0	
61-75	Pressure at the fifth node	FP	0.0	

One DATA SEPARATOR card precedes the PRESSURE INPUT data cards. These cards are required only if Col. 30 of the RUN CONTROL II card is set to P. The values of pressure for boundary nodes may be left blank because these values are supplied on the BOUNDARY NODE DATA cards. Use as many cards as required to define all the system pressures.

TEMPERATURES CARD

Col.(s)	Data Description	Data Type	Default Value	Maximum Value
1-15	Temperature (F) at the first node	FP	atmospheric	
16-30	Temperature at the second node	FP		
31-45	Temperature at the third node	FP		
46-60	Temperature at the fourth node	FP		
61-75	Temperature at the fifth node	FP		

One DATA SEPARATOR card precedes the TEMPERATURE INPUT data cards. These cards are required only if Col. 35 of the RUN CONTROL II CARD is set to T. The values of temperature for boundary nodes may be left blank because these values are supplied on the BOUNDARY NODE DATA cards. Use as many cards as required to define all the system temperatures.

C. Restart

Restart is an option that allows a solution to be interrupted and then continued. This option also allows a solution to begin without any system flows. Basically, the values of the independent parameters defining the state of flow in the system at the time of the interrupt are saved and used as the starting point for the restarted solution. The values of dependent parameters also are saved for plotting purposes. Although the configuration or connection network (that is, system of nodes and branches) should not be changed, its geometry can be changed to reflect any new physical features. These changes might be in volumes, areas, resistance coefficients, or even in functions. Several types of restarts are possible: (1) a restart immediately following steady state, (2) a restart during a transient, and (3) a restart of a restart. Columns 4-5 of RUN CONTROL CARD 1 are used to specify the types "SP," "TP," and "RP," respectively. These symbols signal the program to prepare a complete input file that includes all of the parameters for the last calculation time step. This file, named REST, becomes the data source for the restart solution. REST must be switched to INPUT before it can be executed. This new input file contains a run option "RS" for the actual restart run. However, this option can be changed to "RP" if further restart is needed. The saved values of flow

RESTART DECK

Card Type	Card Description
1	Header card containing the information * RESTART DATA in Cols. 1-16
2	Pressure card(s). Five values of pressure (in. w.g.) are included per card (Cols. 1-15, 16-30, ... 60-75). All system pressures (1 to the total number of nodal points) are defined on these cards.
3	Temperature card(s). Five values of temperature (F) are included per card (Cols. 1-15, 16-30, ... 60-75). All system temperatures (1 to the total number of nodal points) are defined on these cards.
4	Volume flows. Five values of flow (cfm) appear on each card formatted in the same manner as those in 2. All branch flows (1 to the total number of branches) are defined on these cards.
5	Mass flows. Five values of flow (lb/s) appear on each card formatted in the same manner as those in 2. All branch flows (1 to the total number of branches) are defined on these cards.
6	Forward resistance coefficients. Each branch resistance is defined, five per card as in 2, in order of increasing branch number (1 to total number of branches).
7	Backward resistance coefficients. Each branch resistance is defined, five per card as in 2, in order of increasing branch number (1 to total number of branches).
8	Filter laminar coefficients. Five values are included per card (Cols. 1-15, 16-30, ... 60-75). All (1 to the total number of filter types) are defined on these cards.
9	Filter turbulent coefficients. Five values are included per card (Cols. 1-15, 16-30, ... 60-75). All (1 to the total number of filter types) are defined on these cards.

parameters are categorized and labeled for ease of identification at the end of REST. The specific entries within a given category are listed in ascending order by either nodes or branches as noted. The format used is 5(E15.8). The parameters are (1) pressures (nodes), (2) temperatures (nodes), (3) volume flows (branches), (4) mass flows (branches), (5) forward resistance coefficients (branches), (6) backward resistance coefficients (branches), (7) filter laminar coefficients (filters), and (8) filter turbulent coefficients (filters).

V. CODE OUTPUT

A. Summary

EVENT output files are called OUTPUT, TAPE10, and TAPE13. All the printed output is on OUTPUT and can be accessed through a line printer. These data are presented in formats that are designed to provide adequate diagnostics for debugging and an easy-to-read display of the final answers. Both printed and plotted displays of the answers are given. A summary of extreme values spanning the entire period of the problem is produced at the end of the problem. Pressures and flows are inspected at each time step during the calculation in compiling data for this list so that extreme values are not missed by poor selection of output frequency. Frequently, one might wish output lists for a specific point in time not covered in the selection of output frequency. A maximum of three special output times may be selected. These special output times do not appear in the printer plots because these points must be equidistant in time. The printed data are broken down into 13 categories.

- I. Exact listing (echo) of input file
- II. Summary of control information and diagnostics
- III. Summary of problem control parameters
- IV. Summary of model control parameters
- V. Summary of nodal type, initial pressure, and branch connections
- VI. Resistance coefficients and critical mach numbers
- VII. Filter branch data
- VIII. Blower branch data
- IX. Summary of solution parameters
- X. Archival list of pressures, temperatures, volume flows, and mass flows
- XI. Archival list of pressure differentials and volume flows
- XII. Summary of extreme values at time
- XIII. Summary of extreme values for the entire problem

B. Printer Plots

Line-printer plots may be requested on the PLOT CONTROL card and the PLOT FRAME DESCRIPTION cards. A maximum of 25 frames can be requested, and a maximum of 4 curves can be put on a single frame. Each curve is identified by an alphabetic character A through D. Overlapping curves are shown by an X at the point of overlap.

When the number of output times is sparse, the program attempts to fill the plot frame page by spacing with blank lines between points. The extreme value summaries can serve as valuable guides in selecting the node or branch candidates for plotting. Further, the final extreme value summary can be checked for missing extremums on the plots. Printer-plots are not precise by their nature; however, they can give the analyst a good picture of how the system behaves.

TAPE13 contains a complete listing of archival data for each time step in chronological order. TAPE13 is used for the printer-plot displays in OUTPUT and for creating TAPE10, which in turn is used for displaying these same plots on a TEKTRONIX terminal or its equivalent. The program that does this is EVPLOT. The printed plots appearing in OUTPUT are done automatically using TAPE13. TAPE13 is also an output file so that the user has an opportunity to make additional plots after the problem has been run. The program for making these additional plots using TAPE13 as its source of raw data is PLTMOR. This program also requires an input file, called INPLT, that defines the desired plots. The flow diagram shown in Fig. 11 summarizes these output options.

The amount of output obtained in case of an abort caused by an input error depends on the time during the solution when this error is encountered. For example, an incorrect format specified in the input resulting from data being out of order will limit the output to Table I shown in Appendix C (echo of input). Modeling inconsistencies are diagnosed when the input echo is read in or when the input data are reworked before entering the solution. Appropriate messages are printed when this happens. An abort during the solution occurs when a particular time-step calculation fails to converge. A message to this effect is printed along with a partial dump of the mass flow rates, pressures, densities, and correction terms being used followed by a printout of Tables VI--XII (Appendix C) for time = 0.0 s and the last time step before the abort occurred.

EVENT's output is designed to help the user easily find discrepancies in the input that result in an incomplete or incorrect solution. For example, an

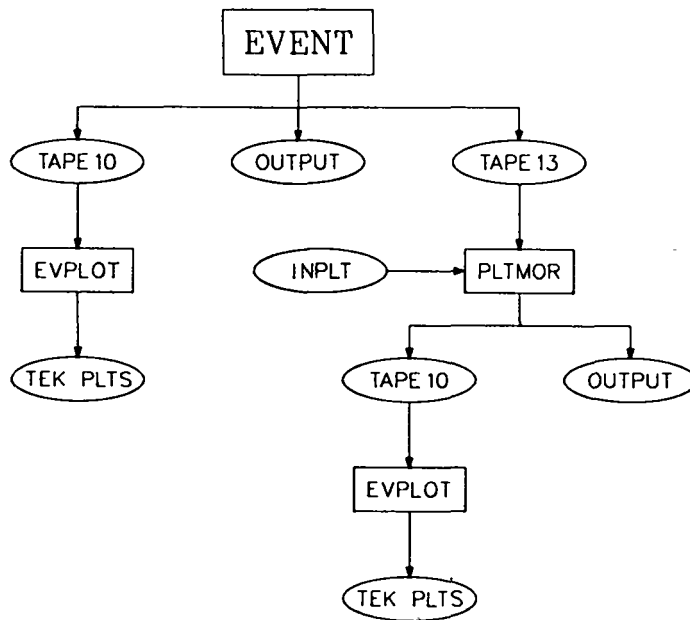

Fig. 11.
Output options.

echo of the input file is presented first to help uncover format errors. If the problem aborts at this point, some diagnostic messages will follow suggesting possible reasons why this happened. When the input data are free of format errors and are consistent, the program prepares for the solution. This preparation produces additional data that give the user an opportunity to check the accuracy of the input. This portion of the output also contains any default values. At this time, nothing can stop the solution from beginning unless a particular time-step calculation fails to converge. When this happens, a dump of pertinent parameters and a list of possible reasons will be printed. The results of the previous time step also will be printed.

All the categories of data are printed automatically and cannot be suppressed or changed by the user. However, the user has control over the amount of output generated. Two options are available.

- o If printed plots are requested, only the results from the first and last calculation times will be printed. This assumes that the plots will be sufficient for a cursory look at the results and these very limited results are enough to bracket the solution.

- o Another option is to request up to three special output times. This option serves two purposes. (1) It permits the user to specify outputs between the evenly spaced times computed by the program, and (2) it permits printouts when the intermediate output times are suppressed.

C. Diagnostic Messages

Diagnostic (warning or error) messages are provided to help the user isolate possible input data or modeling errors. In most cases, the error is easily discerned from the message; however, out-of-order or missing cards tend to produce messages that can confound the user. In these cases, a careful check of the input return list and a review of input preparation (Sec. IV.) can usually isolate the problem.

Diagnostic messages are produced during input processing or the system-solver calculations; hence, there is no set pattern to their location in the output. A list of error and warning messages is given in Appendix B.

VI. SAMPLE PROBLEM

The model for the sample problem is shown in Fig. 12, and the schematic used for EVENT is shown in Fig. 13. This model represents a hypothetical ventilation system consisting of a supply and an exhaust blower, dampers, a relatively large room, a filter plenum, a long duct, and an exhaust stack. The two blower curves also are shown in Fig. 13.

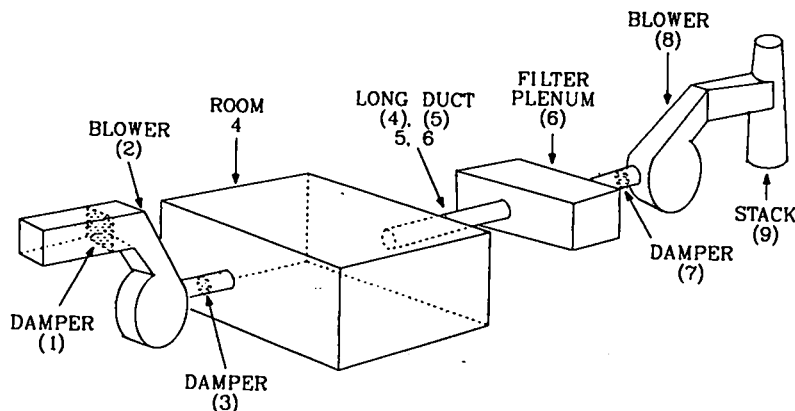

Fig. 12.
Ventilation system for sample problem.

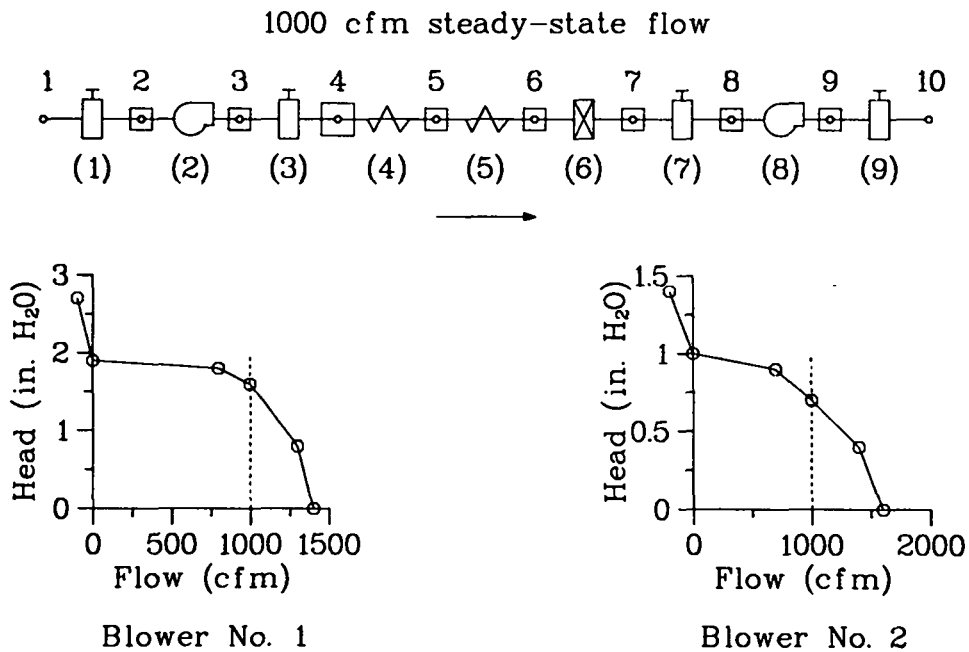

Fig. 13.
EVENT model of the sample problem and blower curves.

An explosive event is assumed to take place in the big room (node 4) with 4.23 lbs of high explosive. The total burn time, including the gas-dynamic relaxation time to reach an equilibrium condition for the entire room, is set at .01 s. The burn history used is a simple ramp up and down with a peak at .005 s. The explosion event is actually prescribed by the mass and energy injection given in the input file, where the geometry and initial condition are also defined. (See Fig. 14.) We add the line number in that file for clarity.

If we further assume that such a severe explosion will not change the structural integrity of the flow system and that the filter behaves normally, then we can obtain the gas-dynamic transient for the given flow network geometry--the pressures (Figs. 15 and 16), temperatures, (Figs. 17 and 18), volume flows (Figs. 19--21), and mass flows (Fig. 22). The peak pressure and peak temperature in node 4 are approximately 54 psig and 1900⁰F, respectively. At the end of 22 s, the pressures decay to values close to steady state, but the temperatures decay at a much slower rate. In fact, the temperatures have just reached the peak at some nodes. This condition should be expected because the explosion is basically thermal; that is, a large percentage of energy is associated with the internal energy because of chemical reaction. The flow plots indicate strong flow reversal for the branches upstream of node 4;

```

1 *
2 EXPLOSION IN LARGE ROOM, NODE 4
3 *
4 • RUN CONTROL 1
5 ST 0.0 0.0005 1.0 3 0.25 0.50 0.75
6 • RUN CONTROL 2
7 500 .0001 P T
8 • PLOT CONTROL
9 2 2 3 1 1
10 • PLOT FRAME DESCRIPTION
11 4 2 3 4 5
12 4 6 7 8 9
13 4 2 3 4 5
14 4 6 7 8 9
15 3 1 2 3
16 3 4 5 6
17 3 7 8 9
18 3 3 4 5
19 1 6
20 • TIME FUNCTION CONTROL AND AMBIANCE DATA
21 .1 2 1 2 14.7 60.0
22 • GEOMETRY AND COMPONENT CONTROL
23 9 2 8 3 2
24 • BRANCH DATA
25 1 1 2 1000. 4.0 V
26
27 2 2 3 1000. 4.0 B 1
28
29 3 3 4 1000. 4.0 V
30
31 4 4 5 1000. 4.0 50. D
32
33 5 5 6 1000. 4.0 50. D
34
35 6 6 7 1000. 4.0 F 1
36
37 7 7 8 1000. 4.0 V
38
39 8 8 9 1000. 4.0 B 2
40
41 9 9 10 1000. 4.0 V
42
43 • BOUNDARY DATA
44 1 0
45 10 0
46 • VOLUME DATA
47 4 1000. 0 0 1 1
48 100.
49 5 200.
50 4.
51 6 200.
52 4.
53 7 20.
54 4.
55 8 20.
56 4.
57 9 20.
58 4.
59 2 20.
60 4.

```

Fig. 14.
Input file.

```

61      3      20.
62      4.
63 • PRESSURE TIME FUNCTIONS (S, PSIG)
64      1      5
65          0.0      0.0      1.0      10.      2.0      10.
66          3.0      0.0      4.0      0.0
67 • TEMPERATURE TIME FUNCTIONS (S, F)
68      1      2
69          0.0      1000.      10.      1000.
70      2      2
71          0.0      -460.      10.      -460.
72 • ENERGY TIME FUNCTIONS (S, BTU/S)
73      1      5
74          0.0      0.0      0.005      5.344E6      0.01      0.0
75          5.0      0.0      6.0      0.0
76 • MASS TIME FUNCTIONS (S, LB/S)
77      1      4      0
78          0.0      0.0      0.005      8.460E2      0.01      0.0
79          5.0      0.0
80      2      4      2
81          0.0      0.0      0.1      30000.      0.2      30000.
82          10.0      0.0
83 • BLOWER FUNCTIONS (CFM, IN. H2O)
84      1      6
85          -100.      2.7      0.0      1.9      800.      1.8
86          1000.      1.6      1300.      0.8      1400.      0.0
87      2      6
88          -200.      1.4      0.0      1.0      700.      0.9
89          1000.      0.7      1400.      0.4      1600.      0.0
90      3      6
91          -100.      2.3      0.0      1.6      770.      1.5
92          940.      1.3      1100.      0.8      1200.      0.0
93 • FILTER FUNCTIONS
94      1      6.5849E5      0.0
95      2      0.0      0.0
96 • PRESSURES (IN. W.G.)
97          0.0      -0.5      +1.1      1.0      0.9
98          0.8      -0.2      -0.3      0.4      0.0
99 • TEMPERATURES (F)
100          60.      60.      60.      60.      60.
101          60.      60.      60.      60.      60.

```

Fig. 14.
Input file (cont).

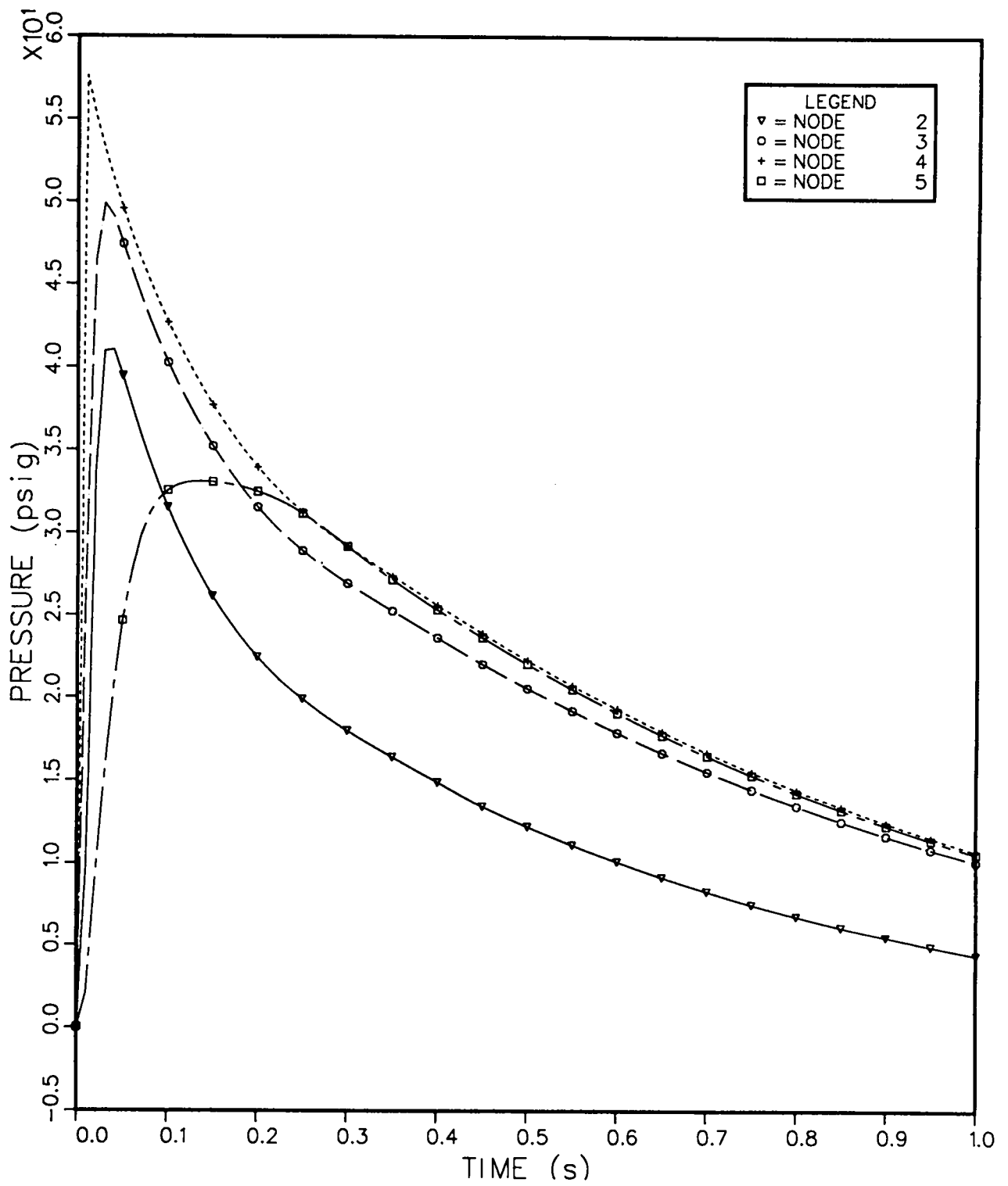

Fig. 15.
Pressures.

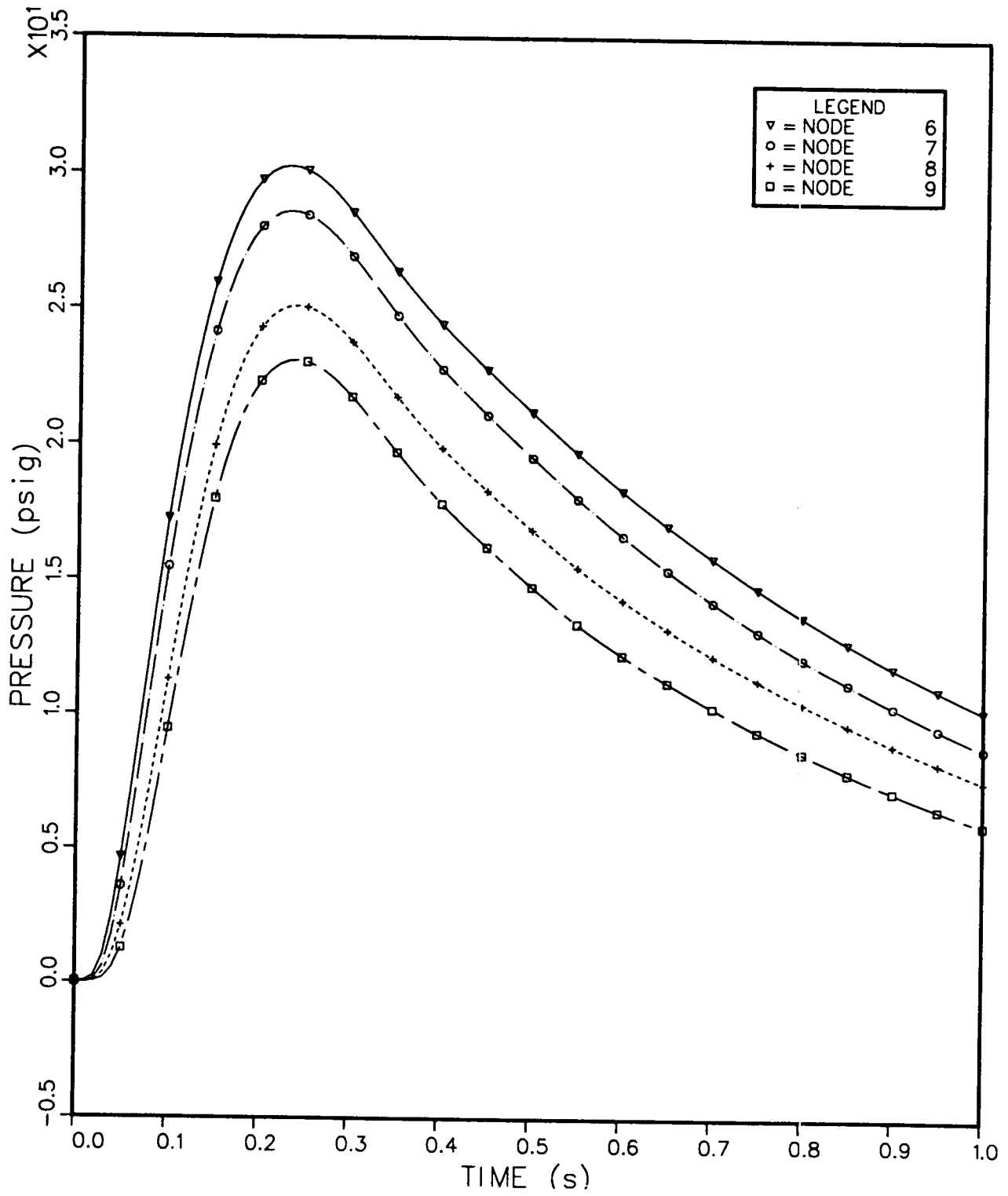

Fig. 16.
Pressures.

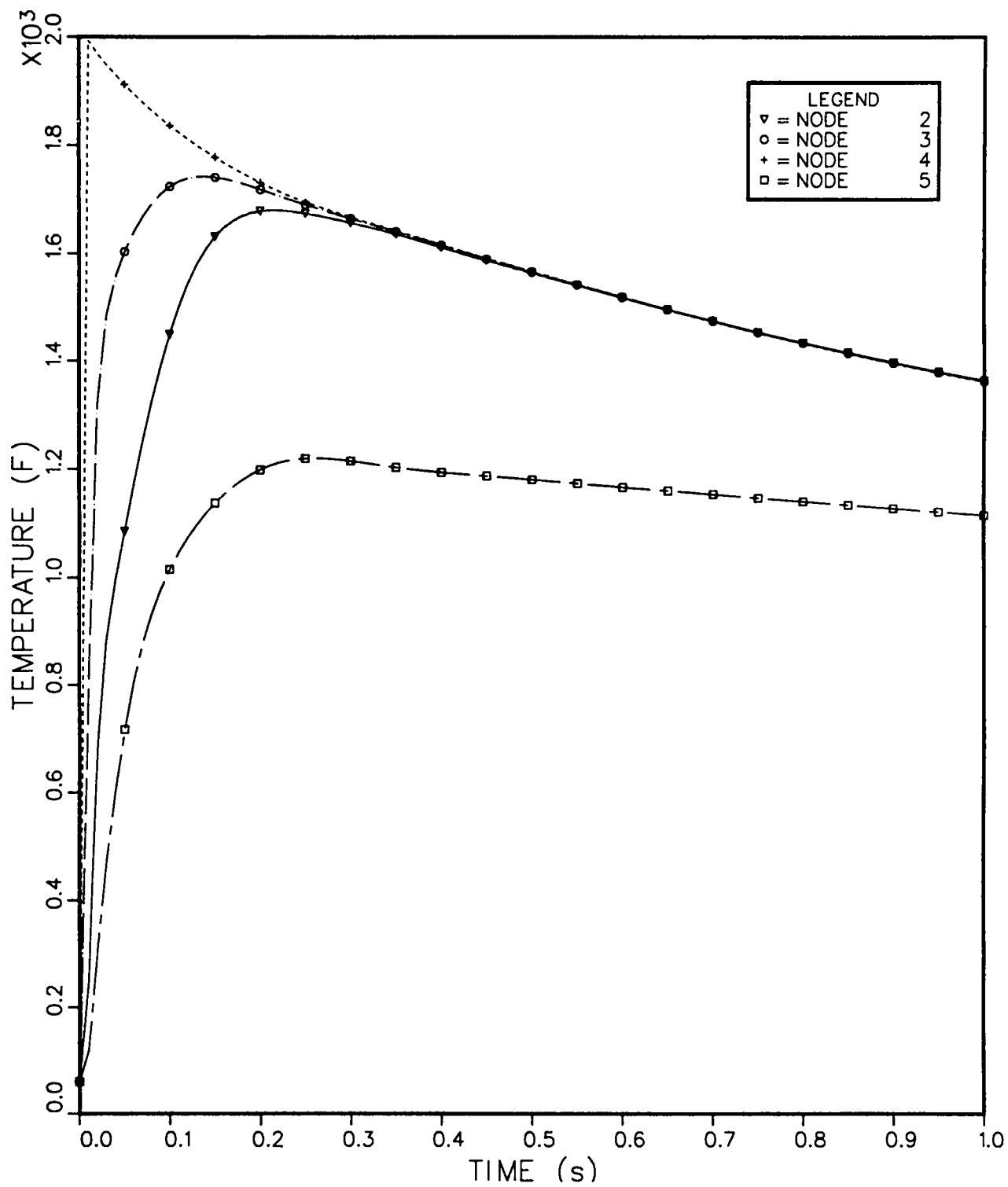

Fig. 17.
Temperatures.

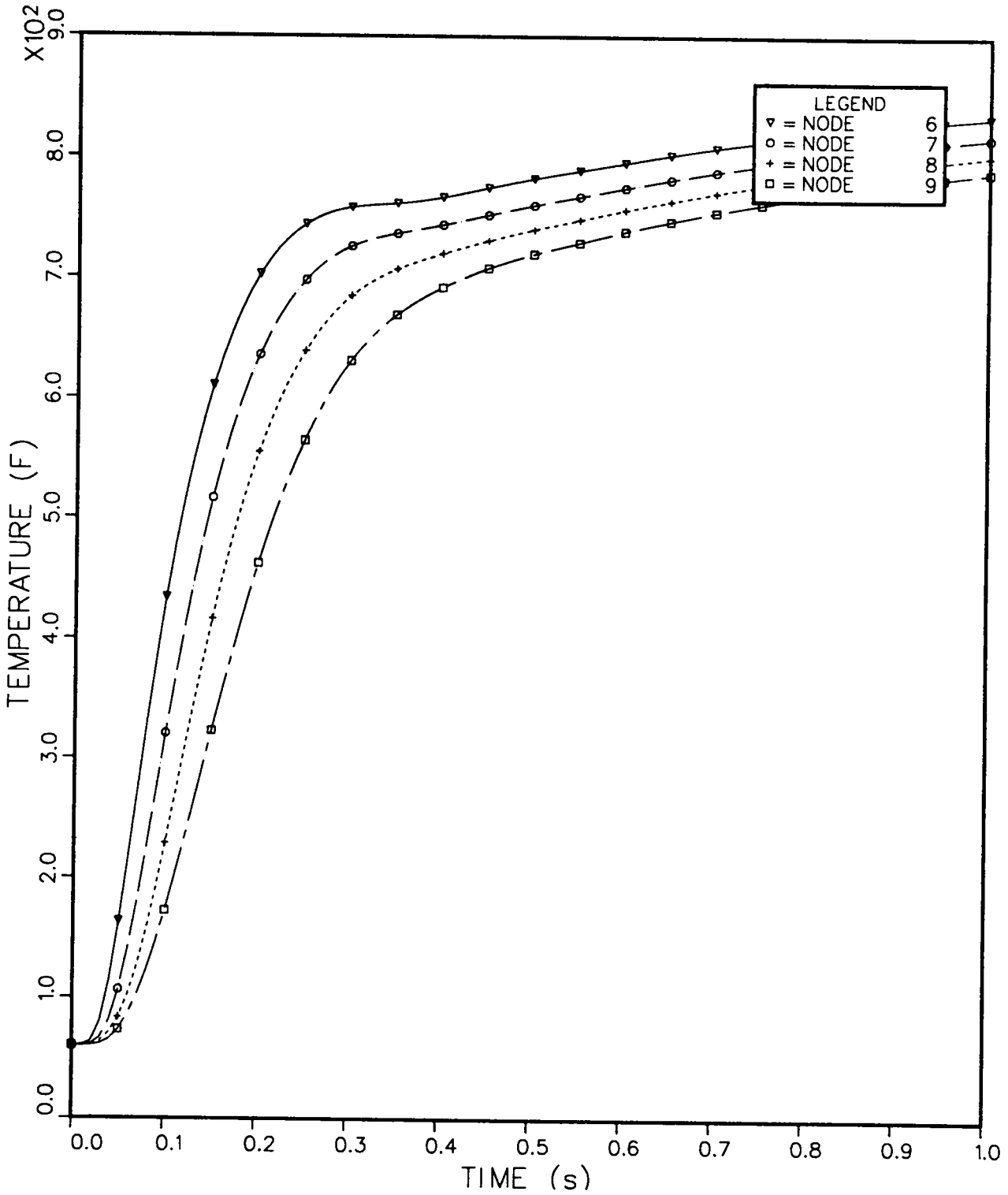

Fig. 18.
Temperatures.

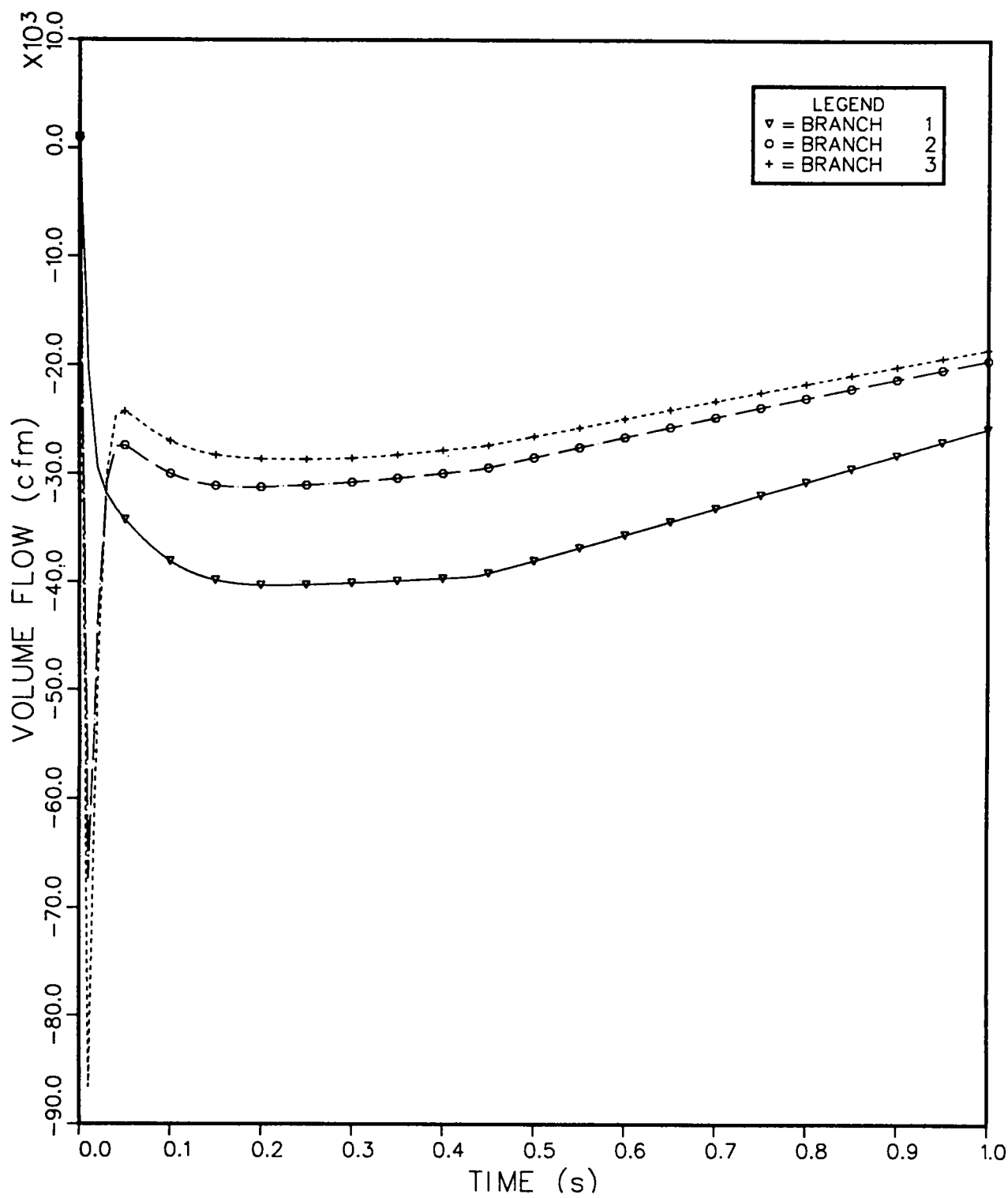

Fig. 19.
Volume flows.

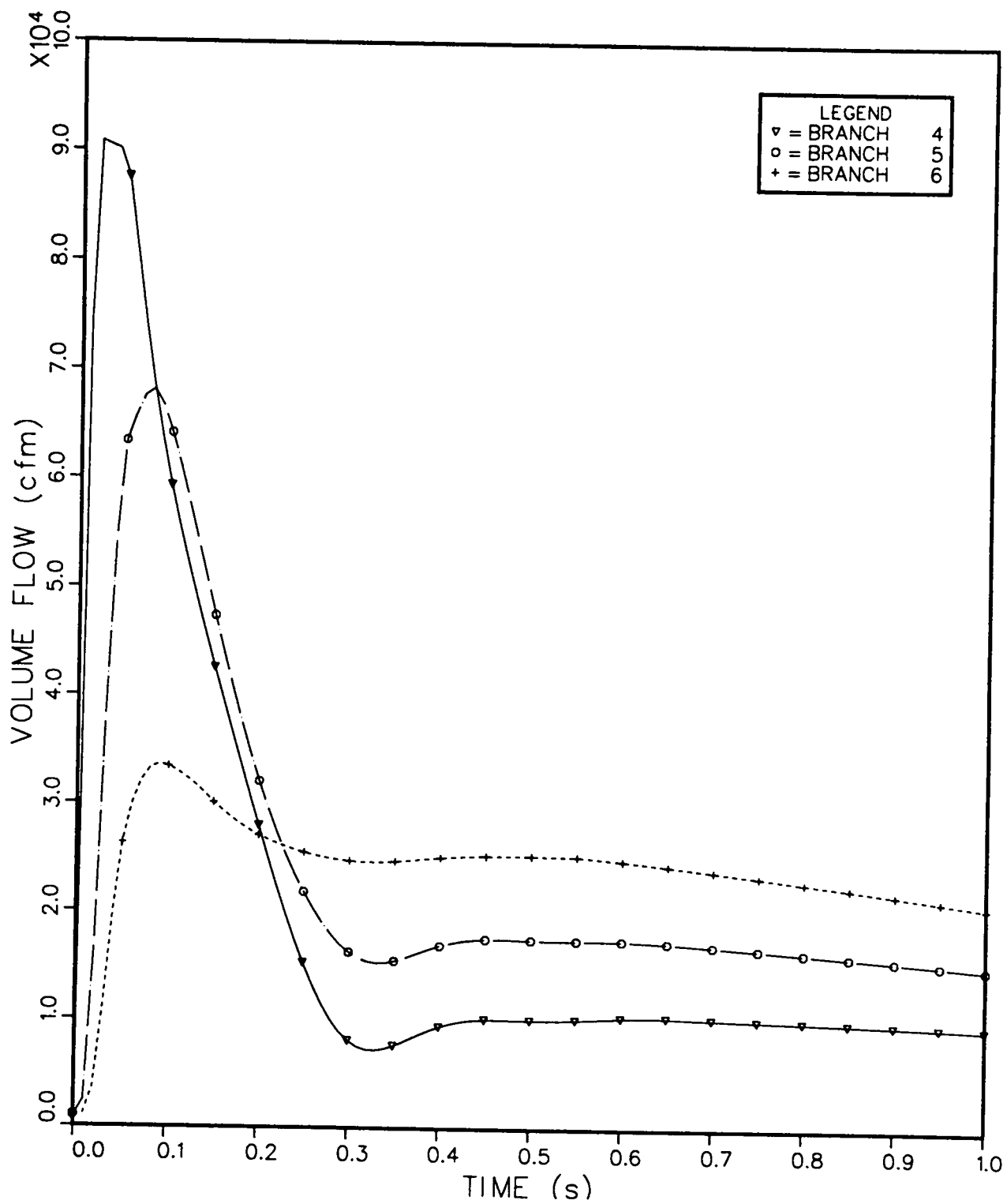

Fig. 20.
Volume flows.

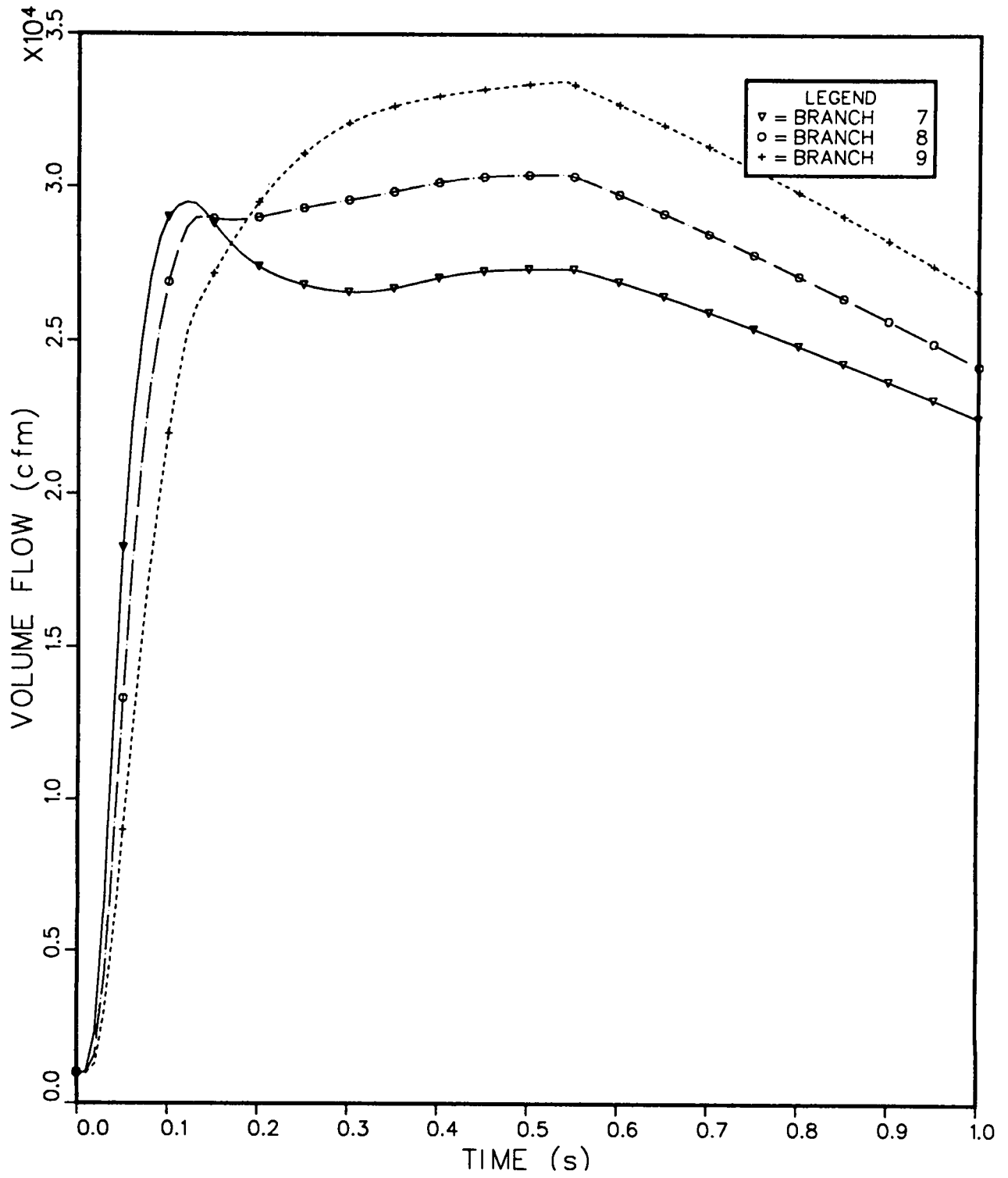

Fig. 21.
Volume flows.

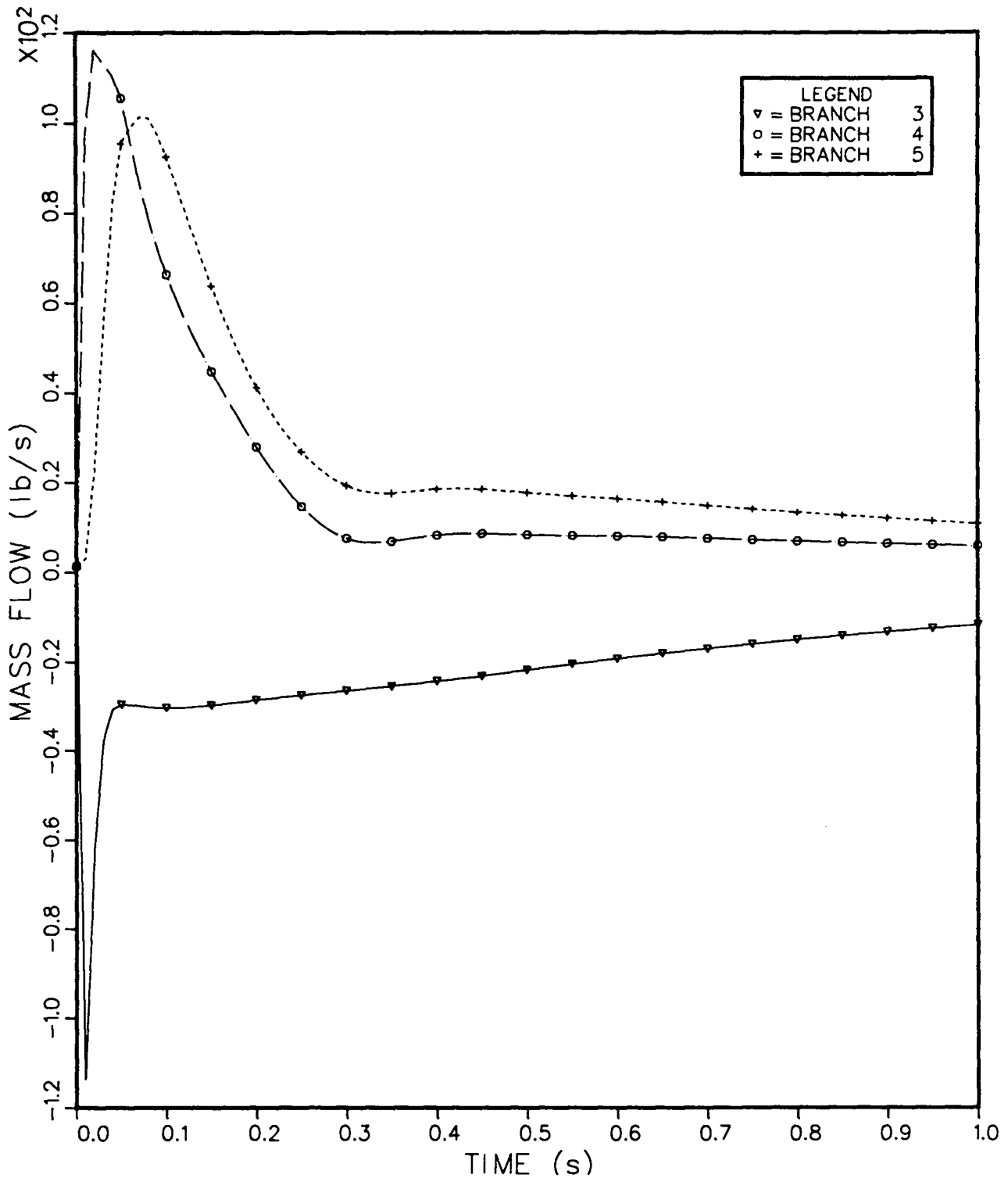

Fig. 22.
Mass flows.

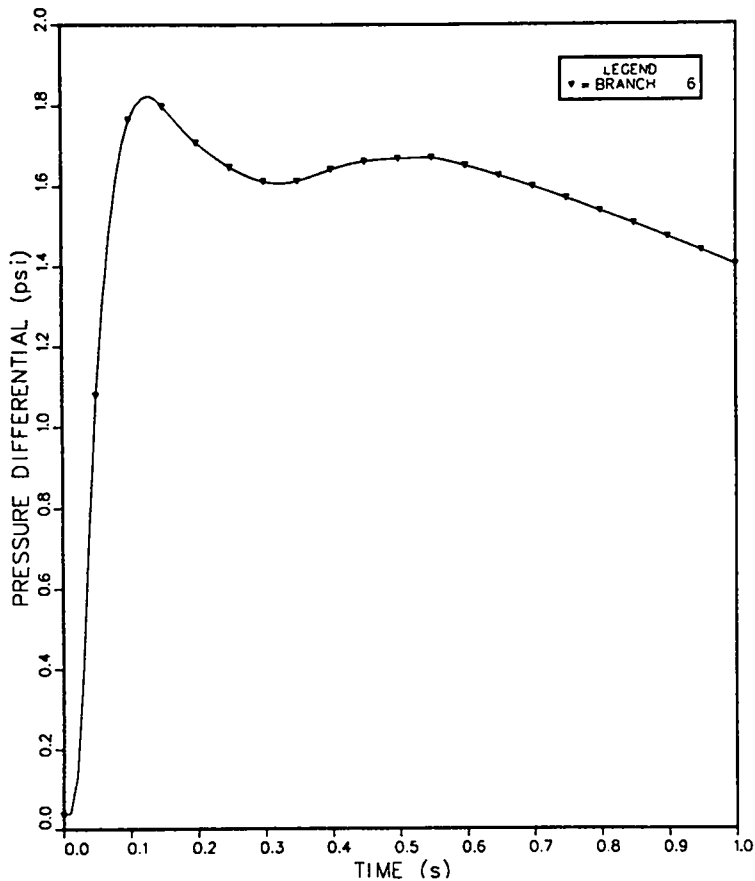

Fig. 23.
Pressure differential.

interestingly, the mass flows return to normal much sooner than the volume flows. This is again a result of the high-temperature (or low-density) condition in the flow network. The pressure differential across the only filter in the system (branch no. 6) is shown in Fig. 23.

A complete listing of the output file OUTPUT is given in Appendix C.

APPENDIX A

GAS-DYNAMICS SUMMARY

I. INTRODUCTION

This discussion includes a very brief summary of the gas dynamics used in the EVENT code. The reader should see Ref. 1 for a more detailed discussion of the theoretical and numerical formulation of the working equations.

The lumped-parameter method is the basic formulation that describes a ventilation system or any other air pathway. The same method is used for the computer code TVENT,² which can handle tornado-induced transients. No spatial distribution of parameters is considered in this approach, although an effect of spatial distribution can be approximated by noding. Network theory (using the lumped-parameter method) includes a number of system elements, called branches, joined at certain points, called nodes. Ventilation system components that exhibit flow resistance and inertia, such as dampers, ducts, valves, and filters, and that exhibit flow potential, such as blowers, are located within the branches of the system.

The connection points of branches are nodes for components that have finite volumes (such as rooms, gloveboxes, plenums, and even ducts) and for boundaries where the volume is practically infinite. Therefore, all internal nodes should possess some finite volume where fluid mass and energy storage may be taken into account.

II. MASS EQUATION

The continuity equation is applied at each internal node. The mass equation for nodes that allows mass accumulation is

$$V \frac{d\rho}{dt} = \sum_k q_k \dot{m}_k + \dot{M}_s, \quad (\text{A-1})$$

where \dot{m}_k is the mass flow rate in branch k , and ρ is the density of the node. The value q_k is used to adjust for the proper flow direction in relation to the node; $q_k = +1$ for the downstream node of a branch or -1 for the upstream node. \dot{M}_s is the user-specified mass source per unit time for the volume, and V is the volume of the node.

III. ENERGY EQUATION

Both the amount and rate of energy release from an explosive event can have profound effects on the gas dynamics of a system. The energy equation used in the EVENT code is expressed below.

$$\frac{dp}{dt} = \frac{R}{C_v V} \left[\sum_k q_k \dot{m}_k \left(C_p T_k + \frac{v_k^2}{2} \right) + \dot{M}_s C_p T_s + \dot{E}_s \right]. \quad (A-2)$$

The nodal pressure is p ; R , C_v , and C_p represent the gas constant, specific heat at constant volume, and specific heat at constant pressure, respectively. T_k and v_k are the branch gas temperature and velocity. The temperature associated with mass addition is T_s , and the energy addition is \dot{E}_s . A perfect gas law has been used to obtain this expression.

IV. MOMENTUM EQUATION

A momentum equation of incompressible form for a duct with constant area is used.

$$\frac{\ell}{A} \frac{d\dot{m}}{dt} = - (p_2 - p_1) - \frac{f\ell}{D} \frac{1}{A^2} \frac{\dot{m}|\dot{m}|}{2\rho}, \quad (A-3)$$

where ℓ and A are the duct length and cross-section area. The values f and D represent the Moody friction factor and hydraulic diameter. For a branch with sudden area change, we add the momentum equations for the three legs and use the interface continuity relations. Then, we obtain

$$I \frac{d\dot{m}}{dt} = (p_i - p_j) - K_{\text{eff}} \frac{1}{A^2} \frac{\dot{m}|\dot{m}|}{2\rho}, \quad (A-4)$$

where

$$I = \frac{\ell_i}{2A_i} + \frac{\ell}{A} + \frac{\ell_j}{2A_j}, \quad \text{and} \quad (A-5)$$

$$K_{\text{eff}} = \left(\frac{f\ell_i}{2D_i} + K_i \right) \left(\frac{A}{A_i} \right)^2 + \left(\frac{f\ell}{D} + K \right) + \left(\frac{f\ell_j}{2D_j} + K_j \right) \left(\frac{A}{A_j} \right)^2. \quad (A-6)$$

I represents the inertia effect of the flow path between nodal points i and j. This includes the rooms as well as the duct. K_{eff} is the total effective resistance coefficient; the minor losses, such as turning, entrance, and exit, are represented by the K's.

V. CHOKING OF COMPRESSIBLE FLOW WITH DISSIPATION

The steady-state flow rate in incompressible flow is determined by the pressure drop. In compressible flow, the flow rate will reach a maximum value regardless of how much the downstream pressure is decreased if the upstream pressure is constant. This phenomenon is choking.

We will investigate the quasi-steady compressible flow inside a constant-area duct where the usual one-dimensional approximation is assumed. Heat transfer is not allowed, but a friction effect is present. For a duct with friction loss, the Mach number at the duct entrance (location 1) can reach a maximum and the value is less than 1. This upstream critical Mach number M_1 is uniquely related to the friction loss, so that

$$\dot{m} = \rho_1 v_1 A = AM_1 \sqrt{\gamma p_1 \rho_1} \quad . \quad (\text{A-7})$$

This is the maximum allowable mass flow rate that a particular branch can supply for a given condition at 1. This flow rate will be compared with that from the momentum equation. Choked flow is used if the former is smaller.

VI. BLOWER MODEL

Blowers provide the driving force to the flow in a system. Specifically, we need to know the volume flow rate for given pressure head condition. Usually, we can obtain a relationship from the manufacturer as follows:

$$\Delta p = f(Q) \quad , \quad (\text{A-8})$$

where Δp is the pressure rise through the blower and Q represents the flow rate. The function is given either in tabulated form or as a curve. For the time being, we will use only this quasi-steady and constant-density relation in our code.

VII. FILTER MODEL

A model that includes both laminar and turbulent dissipation is used in this code.

$$\Delta p = K_L \mu \frac{Q}{A^{3/2}} + K_T \frac{\rho Q^2}{2A^2} , \quad (\text{A-9})$$

with Δp being the pressure drop, Q the volume flow rate, μ the viscosity, ρ the gas density, and A the filter frontal area. K_L and K_T are two empirical coefficients representing the laminar and turbulent effects. This model is developed from the concept of fluid flow through porous media. Some experimental data have confirmed the nonlinear behavior of the filter at high flow rates.³

VIII. NUMERICAL SCHEME

We can always cast the momentum equation with friction and inertia, choking flow, blower flow, or filter flow into a linearized form

$$\dot{m} = \tilde{A} - \tilde{C} \delta p - \tilde{E} \delta \rho . \quad (\text{A-10})$$

\tilde{A} is an estimate of the mass flow rate, δp and $\delta \rho$ are the pressure and density correction terms at each nodal location, and \tilde{C} and \tilde{E} are the coefficients resulting from the Taylor expansion of Eqs. (A-4) and (A-7)---(A-9). The substitution of Eq. (A-10) into the mass and energy conservations, Eqs. (A-1) and (A-2), should yield the results of δp and $\delta \rho$ and the new flow rate. The iterative process continues until both the pressure and density corrections approach zero and the system is balanced. Additional detail can be found in a separate document.⁴ Some aspects of the physical modelings have been verified by experiments.⁵

APPENDIX B

DIAGNOSTICS

During the development of the EVENT computer code, a substantial part of the total effort was devoted to helping users identify possible input and problem errors through extensive diagnostic messages. Most of the input errors are listed in Table II in Appendix C; however, not all errors can be detected with just one run because they are separated under different categories as we will see later. The user must rerun the INPUT file to clear all errors step by step. Even so, a successful run is not guaranteed because each problem is unique and a good modeling strategy relies on experience. We will present some major input errors according to the detection sequences.

A. Time errors

For any normal nonrestart run, the problem start time is set at zero if the total problem is less than the specified value. However, in the case of a restart run, the problem start time cannot be greater than the total problem time.

B. Plot control errors

The total number of plot frames cannot exceed the maximum allowable value of 25.

C. Plot frame control errors

Only four curves are allowed for each plot frame; in addition, the curve number cannot be zero.

D. Geometry and component control errors

The maximum numbers of branches, nodes, boundaries, volumes, blower types and filter types cannot exceed the values given in Table I. The number of branches or nodes also cannot be zero.

E. Plot frame control errors, 2

After the numbers of branches and nodes are declared and accepted, the code will check each node or branch number for the plot curve in the PLOT FRAME DESCRIPTION card. The number cannot exceed the value declared in the GEOMETRY AND COMPONENT CONTROL card.

F. Time function errors

Any time function number cannot exceed 5.

G. Branch data errors

The branch number can neither be greater than the declared value nor zero. The upstream or downstream node of each branch must stay in the declared range but not be zero. For a blower branch, the blower function number used must be greater than zero and within the limit. A filter branch can use no filter function at all. In case it does, the number must be within the declared range. Finally, the flow area must be greater than zero.

H. Boundary data errors

The node number used must be declared, and the value must not exceed the specified number of nodes. Any time function used must be within the specified limit.

I. Volume data errors

The nodal designation in the EVENT code is either boundary or volume, and the latter must contain finite volume value. The node number cannot exceed the maximum specified value; also, any time function used must be within the specified range. They should be used in proper combination. In case the volume flow cross-section area is not given, a very large value is assigned.

J. Time function data errors

More time functions can be included in the INPUT file even though some are not used; this provides flexibility in using the same file for different runs with minor change. The function identification number cannot exceed the specified value. The time sequence in these functions must be in ascending order and the number of data sets cannot exceed 100.

K. Blower data errors

The EVENT code can accommodate up to 20 different blower functions, although some are not used in the actual run. The identification number cannot be zero or exceed the specified limit for each blower. The number of total data sets must not be greater than the allowable value, and it cannot be zero. The described pressure head must be monotonically descending. On the other hand,

the volume flow must be monotonically ascending. An error message will appear if any of the conditions is violated.

L. Filter data errors

The filter identification can neither be zero nor greater than the specified maximum. If the turbulent coefficient is not given, the filter is treated as a linear resistive element.

M. Resistance errors

For all resistive branches such as valves, dampers, ducts and filters, the resistance must be specified or can be calculated from the given pressure differential and flow rate. Otherwise, an error message would appear.

N. Node connection errors

Any node specified in a flow network must connect with other nodes in the system. A fatal error message will appear if there is one node that does not have a connection. If a volume node makes only one connection, a warning message would result.

O. Area errors

The volume cross-section area must be equal to or greater than the areas of the branches connected to that volume. Otherwise, an error message would appear and the run would stop.

APPENDIX C

SAMPLE PROBLEM OUTPUT

For the convenience of the users running the sample problem with the input file given in Fig. 14, we include the complete printer output here.

```

.....
.....
***
***
*** EEEEEEE VV      VV EEEEEEE NN      NN TTTTTTT ***
*** EEEEEEE VV      VV EEEEEEE NNN     NN TTTTTTT ***
*** EE          VV  VV EE          NNNN   NN   TT   ***
*** EE          VV  VV EE          NNNNN  NN   TT   ***
*** EEEEEEE    VV  VV EEEEEEE  NN NNN  NN   TT   ***
*** EEEEEEE    VV  VV EEEEEEE  NN  NNN NN   TT   ***
*** EE          VVVV  EE          NN  NNNNN  TT   ***
*** EE          VVVV  EE          NN  NNNN   TT   ***
*** EEEEEEEEE   VV   EEEEEEEEE NN   NNN   TT   ***
*** EEEEEEEEE   VV   EEEEEEEEE NN     NN   TT   ***
***
***
*** DEVELOPED AT LOS ALAMOS NATIONAL LABORATORY ***
*** LOS ALAMOS, NEW MEXICO 87545 ***
*** JUNE 1982 ***
***
***
.....
.....

```

TABLE I (PAGE 1)

EXACT LISTING (ECHO) OF INPUT FILE

	10	20	30	40	50	60	70	80
1234567890123456789012345678901234567890123456789012345678901234567890								
1\$								
2\$ EXPLOSION IN LARGE ROOM, NODE 4								
3\$								
4\$ RUN CONTROL 1								
5\$ ST 0.0 0.0005 1.0 3 0.25 0.50 0.75								
6\$ RUN CONTROL 2								
7\$ 500 .0001 P T								
8\$ PLOT CONTROL								
9\$ 2 2 3 1 1								
10\$ PLOT FRAME DESCRIPTION								
11\$ 4 2 3 4 5								
12\$ 4 6 7 8 9								
13\$ 4 2 3 4 5								
14\$ 4 6 7 8 9								
15\$ 3 1 2 3								
16\$ 3 4 5 6								
17\$ 3 7 8 9								
18\$ 3 3 4 5								
19\$ 1 6								
20\$ TIME FUNCTION CONTROL AND AMBIANCE DATA								
21\$ 1 2 1 2 14.7 60.0								
22\$ GEOMETRY AND COMPONENT CONTROL								
23\$ 9 2 8 3 2								
24\$ BRANCH DATA								
25\$ 1 1 2 1000. 4.0 V								
26\$								
27\$ 2 2 3 1000. 4.0 B 1								
28\$								
29\$ 3 3 4 1000. 4.0 V								
30\$								
31\$ 4 4 5 1000. 4.0 50. D								
32\$								
33\$ 5 5 6 1000. 4.0 50. D								
34\$								
35\$ 6 6 7 1000. 4.0 F 1								
36\$								
37\$ 7 7 8 1000. 4.0 V								
38\$								
39\$ 8 8 9 1000. 4.0 B 2								
40\$								
41\$ 9 9 10 1000. 4.0 V								
42\$								
43\$ BOUNDARY DATA								
44\$ 1 0								
45\$ 10 0								
46\$ VOLUME DATA								
47\$ 4 1000. 0 0 1 1								
48\$ 100.								
49\$ 5 200.								
50\$ 4.								
51\$ 6 200.								
52\$ 4.								

TABLE 1 (PAGE 2)

EXACT LISTING (ECHO) OF INPUT FILE

	10	20	30	40	50	60	70	80
1234567890123456789012345678901234567890123456789012345678901234567890								
53\$	7	20.						
54\$		4.						
55\$	8	20.						
56\$		4.						
57\$	9	20.						
58\$		4.						
59\$	2	20.						
60\$		4.						
61\$	3	20.						
62\$		4.						
63\$	PRESSURE TIME FUNCTIONS (S, PSIG)							
64\$	1	5						
65\$		0.0	0.0	1.0	10.	2.0	10.	
66\$		3.0	0.0	4.0	0.0			
67\$	TEMPERATURE TIME FUNCTIONS (S, F)							
68\$	1	2						
69\$		0.0	1000.	10.	1000.			
70\$	2	2						
71\$		0.0	-460.	10.	-460.			
72\$	ENERGY TIME FUNCTIONS (S, BTU/S)							
73\$	1	5						
74\$		0.0	0.0	0.005	5.344E6	0.01	0.0	
75\$		5.0	0.0	6.0	0.0			
76\$	MASS TIME FUNCTIONS (S, LB/S)							
77\$	1	4	0					
78\$		0.0	0.0	0.005	8.460E2	0.01	0.0	
79\$		5.0	0.0					
80\$	2	4	2					
81\$		0.0	0.0	0.1	30000.	0.2	30000.	
82\$		10.0	0.0					
83\$	BLOWER FUNCTIONS (CFM, IN. H2O)							
84\$	1	6						
85\$		-100.	2.7	0.0	1.9	800.	1.8	
86\$		1000.	1.6	1300.	0.8	1400.	0.0	
87\$	2	6						
88\$		-200.	1.4	0.0	1.0	700.	0.9	
89\$		1000.	0.7	1400.	0.4	1600.	0.0	
90\$	3	6						
91\$		-100.	2.3	0.0	1.6	770.	1.5	
92\$		940.	1.3	1100.	0.8	1200.	0.0	
93\$	FILTER FUNCTIONS							
94\$	1	6.5849E6	0.0					
95\$	2	0.0	0.0					
96\$	PRESSURES (IN. W.G.)							
97\$		0.0		-0.5	+1.1	1.0	0.9	
98\$		0.8		-0.2	-0.3	0.4	0.0	
99\$	TEMPERATURES (F)							
100\$		60.		60.	60.	60.	60.	
101\$		60.		60.	60.	60.	60.	

TABLE II
SUMMARY OF CONTROL INFORMATION AND DIAGNOSTICS

PRESSURE FRAMES = 2
TEMPERATURE FRAMES = 2
VOLUME FLOW FRAMES = 3
MASS FLOW FRAMES = 1
DIFFERENTIAL PRESSURE FRAMES = 1

PRESSURE FUNCTIONS = 1
TEMPERATURE FUNCTIONS = 2
ENERGY FUNCTIONS = 1
MASS FUNCTIONS = 2

BRANCHES = 9
NODES = 10
BOUNDARIES = 2
VOLUMES = 8
BLOWER TYPES = 3
FILTER TYPES = 2

-----PRESSURES READ IN (NOT CALC.FROM DIFP)

-----TEMPERATURES READ IN

... CAUTION ...

BRANCH 4 VOLUME (FT3) = 200.00 APPROACHING MIN. VOLUME(20.000)

TABLE III
SUMMARY OF PROBLEM CONTROL PARAMETERS

PROBLEM TYPE	SS/TRANS	MAXIMUM ITERATIONS PER TIME STEP	500
TIME STEP (S)	5.0000E-04	CONVERGENCE CRITERION	1.0000E-04
START TIME (S)	0.000	RELAXATION PARAMETER	1.00000
TOTAL TIME (S)	1.000		

OUTPUT TIMES (S)

.0000	.0100	.0200	.0300	.0400	.0500	.0600	.0700
.0800	.0900	.1000	.1100	.1200	.1300	.1400	.1500
.1600	.1700	.1800	.1900	.2000	.2100	.2200	.2300
.2400	.2500	.2600	.2700	.2800	.2900	.3000	.3100
.3200	.3300	.3400	.3500	.3600	.3700	.3800	.3900
.4000	.4100	.4200	.4300	.4400	.4500	.4600	.4700
.4800	.4900	.5000	.5100	.5200	.5300	.5400	.5500
.5600	.5700	.5800	.5900	.6000	.6100	.6200	.6300
.6400	.6500	.6600	.6700	.6800	.6900	.7000	.7100
.7200	.7300	.7400	.7500	.7600	.7700	.7800	.7900
.8000	.8100	.8200	.8300	.8400	.8500	.8600	.8700
.8800	.8900	.9000	.9100	.9200	.9300	.9400	.9500
.9600	.9700	.9800	.9900	1.0000			

PRESSURE TIME FUNCTION DATA (PSIG)

T(S)	FT	T(S)	FT	T(S)	FT	T(S)	FT	T(S)	FT
FN. NO. --- 1									
0.	0.	1.000E+00	1.000E+01	2.000E+00	1.000E+01	3.000E+00	0.	4.000E+00	0.

TEMPERATURE TIME FUNCTION DATA (F)

T(S)	FT	T(S)	FT	T(S)	FT	T(S)	FT	T(S)	FT
FN. NO. --- 1									
0.	1.000E+03	1.000E+01	1.000E+03						
FN. NO. --- 2									
0.	-4.600E+02	1.000E+01	-4.600E+02						

ENERGY TIME FUNCTION DATA (BTU/S)

T(S)	FT	T(S)	FT	T(S)	FT	T(S)	FT	T(S)	FT
FN. NO. --- 1									
0.	0.	5.000E-03	5.344E+06	1.000E-02	0.	5.000E+00	0.	6.000E+00	0.

MASS TIME FUNCTION DATA (LB/S)

T(S)	FT	T(S)	FT	T(S)	FT	T(S)	FT	T(S)	FT

```

-----
FN. NO. --- 1
0.          0.          5.000E-03  8.460E+02  1.000E-02  0.          5.000E+00  0.
FN. NO. --- 2
0.          0.          1.000E-01  3.000E+04  2.000E-01  3.000E+04  1.000E+01  0.

```

TABLE IV
SUMMARY OF MODEL CONTROL PARAMETERS

```

NUMBER OF BRANCHES = 9      NUMBER OF NODES (BOUNDARY + VOLUME) = 10
NUMBER OF BOUNDARIES = 2   NUMBER OF VOLUMES = 8
NUMBER OF BLOWER TYPES = 3 NUMBER OF FILTER TYPES = 2

```

BRANCH DATA

NO.	IN NODE	OUT NODE	INITIAL FLOW (CFM)	FLOW AREA (FT2)	COMP TYPE	CURVE	EXP Q	RESIST	REV RESIST	INITIAL DELTA-P (IN. H2O)	INERTIA (1/FT)
1	1	2	1000.00	4.00	DAMP	0	2.0 0.	0.	0.	5.000E-01	4.431E-01
2	2	3	1000.00	4.00	BLHR	1	1.0 0.	0.	0.	1.600E+00	0.
3	3	4	1000.00	4.00	DAMP	0	2.0 0.	0.	0.	1.000E-01	4.431E-01
4	4	5	1000.00	4.00	DUCT	0	2.0 0.	0.	0.	1.000E-01	1.250E+01
5	5	6	1000.00	4.00	DUCT	0	2.0 0.	0.	0.	1.000E-01	1.250E+01
6	6	7	1000.00	4.00	FILT	1	1.0 0.	0.	0.	1.000E+00	0.
7	7	8	1000.00	4.00	DAMP	0	2.0 0.	0.	0.	1.000E-01	4.431E-01
8	8	9	1000.00	4.00	BLHR	2	1.0 0.	0.	0.	7.000E-01	0.
9	9	10	1000.00	4.00	DAMP	0	2.0 0.	0.	0.	4.000E-01	4.431E-01

BOUNDARY DATA

AMBIENT PRESSURE = 14.70 (PSIA) AMBIENT TEMPERATURE = 60.00 (F)

NODE NO.	INITIAL PRESSURE (PSIG)	P FN NO.	INITIAL TEMP. (F)	T FN NO.	NODE NO.	INITIAL PRESSURE (PSIG)	P FN NO.	INITIAL TEMP. (F)	T FN NO.	NODE NO.	INITIAL PRESSURE (PSIG)	P FN NO.	INITIAL TEMP. (F)	T FN NO.
1	0.00	0	60.00	0	10	0.00	0	60.00	0					

VOLUME DATA

VOLUME NO.	NOP	NOT	NOC	NOM	VOL. (FT3)	AREA (FT2)
1	4	0	0	1	1.000E+03	1.000E+02
2	5	0	0	0	2.000E+02	4.000E+00
3	6	0	0	0	2.000E+02	4.000E+00
4	7	0	0	0	2.000E+01	4.000E+00
5	8	0	0	0	2.000E+01	4.000E+00
6	9	0	0	0	2.000E+01	4.000E+00
7	2	0	0	0	2.000E+01	4.000E+00
8	3	0	0	0	2.000E+01	4.000E+00

BLOWER FUNCTION DATA

CURVE NO.	SEGMENT	LEFT BOUND(FLOW)	RIGHT BOUND(FLOW)	COEFFICIENTS	
				A	B
1					

	1	-1.000E+02	0.	2.3750E+02	-1.2500E+02
	2	0.	8.000E+02	1.5200E+04	-8.0000E+03
	3	8.000E+02	1.000E+03	2.6000E+03	-1.0000E+03
	4	1.000E+03	1.300E+03	1.6000E+03	-3.7500E+02
2	5	1.300E+03	1.400E+03	1.4000E+03	-1.2500E+02
	1	-2.000E+02	0.	5.0000E+02	-5.0000E+02
	2	0.	7.000E+02	7.0000E+03	-7.0000E+03
	3	7.000E+02	1.000E+03	2.0500E+03	-1.5000E+03
	4	1.000E+03	1.400E+03	1.9333E+03	-1.3333E+03
	5	1.400E+03	1.600E+03	1.6000E+03	-5.0000E+02
3	1	-1.000E+02	0.	2.2857E+02	-1.4286E+02
	2	0.	7.700E+02	1.2320E+04	-7.7000E+03
	3	7.700E+02	9.400E+02	2.0450E+03	-8.5000E+02
	4	9.400E+02	1.100E+03	1.3560E+03	-3.2000E+02
	5	1.100E+03	1.200E+03	1.2000E+03	-1.2500E+02

FILTER FUNCTION DATA

NO.	LAMINAR COEF.	TURBULENT COEF.
---	-----	-----
1	6.5849E+06	0.
2	0.	0.

TABLE V

SUMMARY OF NODE TYPE, INITIAL PRESSURE AND BRANCH CONNECTIONS

NODE NO.	NODE TYPE (-, FOR BOUNDARY +, VOLUME NO+1000)	PRESSURE (IN. W.G.)	ASSOCIATED BRANCHES
-----	-----	-----	-----
1	-1	0.	
2	1007	-5.0000E-01	1 2
3	1008	1.1000E+00	2 3
4	1001	1.0000E+00	3 4
5	1002	9.0000E-01	4 5
6	1003	8.0000E-01	5 6
7	1004	-2.0000E-01	6 7
8	1005	-3.0000E-01	7 8
9	1006	4.0000E-01	8 9
10	-1	0.	

TABLE VI

RESISTANCE COEFFICIENTS AND CRITICAL MACH NUMBERS

(INPUT RESISTANCES SHOULD INCLUDE ENTRANCE AND/OR EXIT LOSSES. IF NOT DONE, THE FRICTION FACTORS BECOME NEGATIVE DURING THE SOLUTION AND RESULT IN NUMERICAL INSTABILITIES. VERY LARGE FRICTION FACTORS WILL NOT CAUSE NUMERICAL PROBLEMS, BUT SHOULD BE EXAMINED FOR UNREASONABLENESS.)

BRANCH NO.	UP. NODE	DN. NODE	FWD RF	REV RF	FWD MACH	REV MACH	AREA(M2)	*INPUT ERROR??*
1	1	2	125.997	125.997	.07383	.07412	.37161	FRICTION TOO HIGH?/AREA TOO LARGE?
3	3	4	25.199	25.199	.15976	.15712	.37161	FRICTION TOO HIGH?/AREA TOO LARGE?
4	4	5	25.199	25.199	.15712	.15976	.37161	FRICTION TOO HIGH?/AREA TOO LARGE?
5	5	6	25.199	25.199	.15712	.15712	.37161	FRICTION TOO HIGH?/AREA TOO LARGE?
7	7	8	25.199	25.199	.15712	.15712	.37161	FRICTION TOO HIGH?/AREA TOO LARGE?
9	9	10	100.797	100.797	.08262	.08223	.37161	FRICTION TOO HIGH?/AREA TOO LARGE?

TABLE VII

FILTER BRANCH DATA

BRANCH NO.	FILTER NO.	LAMINAR COEF.	TURBULENT COEF.
6	1	6.5849E+06	0.

TABLE VIII

BLOWER BRANCH DATA

BRANCH NO.	BLOWER FUNCTION NO.
2	1
8	2

ENTRY TO SYSTEM SOLVER

TABLE IX
SUMMARY OF SOLUTION PARAMETERS

EXPLOSION IN LARGE ROOM, NODE 4

RUN TYPE = ST
 CONVERGENCE CRITERION = 1.0000E-04
 RELAXATION PARAMETER = 1.00
 CALCULATION TIME STEP = 5.0000E-04 (S)
 TOTAL PROBLEM RUN TIME = 1.00000 (S)
 TOTAL ITERATIONS FOR PROBLEM = 9930
 ACTUAL SOLUTION TIME = 15.99 (S)

TABLE X
ARCHIVAL LIST OF PRESSURES, TEMPERATURES
VOLUME FLOWS, AND MASS FLOWS

TIME = 0. (S)

		NODAL PRESSURES (PSIG)									
		0	1	2	3	4	5	6	7	8	9
0	0.	0.	-1.816E-02	3.957E-02	3.598E-02	3.228E-02	2.873E-02	-7.265E-03	-1.087E-02	1.440E-02	
10	0.										
		NODAL TEMPERATURES (F)									
		0	1	2	3	4	5	6	7	8	9
0	6.000E+01	6.000E+01	6.000E+01	6.000E+01	6.000E+01	6.000E+01	6.000E+01	6.000E+01	6.000E+01	6.000E+01	6.000E+01
10	6.000E+01										
		BRANCH VOLUME FLOWS (CFM)									
		0	1	2	3	4	5	6	7	8	9
0		9.992E+02	1.000E+03	9.965E+02	9.967E+02	9.969E+02	9.972E+02	9.997E+02	1.000E+03	9.983E+02	
		BRANCH MASS FLOWS (LB/S)									
		0	1	2	3	4	5	6	7	8	9
0		1.273E+00	1.273E+00	1.273E+00	1.273E+00	1.273E+00	1.273E+00	1.273E+00	1.273E+00	1.273E+00	1.273E+00

TABLE X
 ARCHIVAL LIST OF PRESSURES, TEMPERATURES
 VOLUME FLOWS, AND MASS FLOWS

TIME = 2.5000E-01 (S)

NODAL PRESSURES (PSIG)

	0	1	2	3	4	5	6	7	8	9
0										
10 0.	0.	1.985E+01	2.889E+01	3.121E+01	3.114E+01	3.008E+01	2.843E+01	2.503E+01	2.303E+01	

NODAL TEMPERATURES (F)

	0	1	2	3	4	5	6	7	8	9
0										
10 6.000E+01	6.000E+01	1.674E+03	1.690E+03	1.695E+03	1.219E+03	7.444E+02	6.986E+02	6.401E+02	5.659E+02	

BRANCH VOLUME FLOWS (CFM)

	0	1	2	3	4	5	6	7	8	9
0										
		-4.026E+04	-3.106E+04	-2.870E+04	1.512E+04	2.172E+04	2.550E+04	2.680E+04	2.932E+04	3.111E+04

BRANCH MASS FLOWS (LB/S)

	0	1	2	3	4	5	6	7	8	9
0										
		-2.936E+01	-2.836E+01	-2.750E+01	1.451E+01	2.671E+01	4.272E+01	4.494E+01	4.769E+01	5.155E+01

TABLE XI
 ARCHIVAL LIST OF PRESSURE DIFFERENTIALS AND VOLUME FLOWS
 TIME = 2.5000E-01 (S)

PRESSURE DIFFERENTIAL IN BLOWERS (PSI)							
BRANCH	D. P.	BRANCH	D. P.	BRANCH	D. P.	BRANCH	D. P.
2	9.0365E+00	8	2.0006E+00				
FLOW THROUGH BLOWERS (CFM)							
BRANCH	FLOW	BRANCH	FLOW	BRANCH	FLOW	BRANCH	FLOW
2	-3.1061E+04	8	2.9315E+04				
PRESSURE DROP IN FILTERS (PSI)							
BRANCH	D. P.	BRANCH	D. P.	BRANCH	D. P.	BRANCH	D. P.
6	1.6479E+00						
FLOW THROUGH FILTERS (CFM)							
BRANCH	FLOW	BRANCH	FLOW	BRANCH	FLOW	BRANCH	FLOW
6	2.5501E+04						
PRESSURE DROP IN DAMPERS (PSI)							
BRANCH	D. P.	BRANCH	D. P.	BRANCH	D. P.	BRANCH	D. P.
1	1.9850E+01	3	2.3228E+00	7	3.4058E+00	9	2.3027E+01
FLOW THROUGH DAMPERS (CFM)							
BRANCH	FLOW	BRANCH	FLOW	BRANCH	FLOW	BRANCH	FLOW
1	-4.0257E+04	3	-2.8702E+04	7	2.6796E+04	9	3.1112E+04
PRESSURE DROP IN DUCTS (PSI)							
BRANCH	D. P.	BRANCH	D. P.	BRANCH	D. P.	BRANCH	D. P.
4	6.7038E-02	5	1.0603E+00				
FLOW THROUGH DUCTS (CFM)							
BRANCH	FLOW	BRANCH	FLOW	BRANCH	FLOW	BRANCH	FLOW
4	1.5123E+04	5	2.1720E+04				

TABLE XII
 SUMMARY OF EXTREME VALUES AT TIME = 2.5000E-01 (S)

•	•	•	•	•	•	•	•	•
•	HIGHEST PRESSURE OF	31.21 (PSIG)	OCCURS AT NODE	4				
•	LOWEST PRESSURE OF	0.00 (PSIG)	OCCURS AT NODE	10				
•	HIGHEST TEMPERATURE OF	1695.10 (F)	OCCURS AT NODE	4				
•	LOWEST TEMPERATURE OF	60.00 (F)	OCCURS AT NODE	10				
•	HIGHEST VOLUME FLOW OF	4.0257E+04 (CFM)	OCCURS IN BRANCH	1				
•	LOWEST VOLUME FLOW OF	1.5123E+04 (CFM)	OCCURS IN BRANCH	4				
•	HIGHEST MASS FLOW OF	5.1548E+01 (LB/S)	OCCURS IN BRANCH	9				
•	LOWEST MASS FLOW OF	1.4506E+01 (LB/S)	OCCURS IN BRANCH	4				
•	LARGEST PRESSURE DIFFERENTIAL OF	9.0365E+00 (PSI)	OCCURS IN BLOWER BRANCH	2				
•	LARGEST VOLUME FLOW OF	-3.1061E+04 (CFM)	OCCURS IN BLOWER BRANCH	2				
•	LARGEST PRESSURE DIFFERENTIAL OF	1.6479E+00 (PSI)	OCCURS IN FILTER BRANCH	6				
•	LARGEST VOLUME FLOW OF	2.5501E+04 (CFM)	OCCURS IN FILTER BRANCH	6				
•	LARGEST PRESSURE DIFFERENTIAL OF	2.3027E+01 (PSI)	OCCURS IN DAMPER BRANCH	9				
•	LARGEST VOLUME FLOW OF	-4.0257E+04 (CFM)	OCCURS IN DAMPER BRANCH	1				
•	LARGEST PRESSURE DIFFERENTIAL OF	1.0603E+00 (PSI)	OCCURS IN DUCT BRANCH	5				
•	LARGEST VOLUME FLOW OF	2.1720E+04 (CFM)	OCCURS IN DUCT BRANCH	5				

TABLE X
 ARCHIVAL LIST OF PRESSURES, TEMPERATURES
 VOLUME FLOWS, AND MASS FLOWS

TIME = 5.0000E-01 (S)

NODAL PRESSURES (PSIG)

	0	1	2	3	4	5	6	7	8	9
0		0.	1.224E+01	2.053E+01	2.223E+01	2.200E+01	2.116E+01	1.949E+01	1.682E+01	1.474E+01
10 0.										

NODAL TEMPERATURES (F)

	0	1	2	3	4	5	6	7	8	9
0		6.000E+01	1.563E+03	1.565E+03	1.565E+03	1.181E+03	7.827E+02	7.607E+02	7.406E+02	7.202E+02
10 6.000E+01										

BRANCH VOLUME FLOWS (CFM)

	0	1	2	3	4	5	6	7	8	9
0		-3.796E+04	-2.848E+04	-2.656E+04	1.013E+04	1.756E+04	2.532E+04	2.733E+04	3.041E+04	3.337E+04

BRANCH MASS FLOWS (LB/S)

	0	1	2	3	4	5	6	7	8	9
0		-2.277E+01	-2.232E+01	-2.179E+01	8.322E+00	1.770E+01	3.292E+01	3.449E+01	3.597E+01	3.751E+01

TABLE XI
 ARCHIVAL LIST OF PRESSURE DIFFERENTIALS AND VOLUME FLOWS
 TIME = 5.0000E-01 (S)

PRESSURE DIFFERENTIAL IN BLOWERS (PSI)							
BRANCH	D. P.	BRANCH	D. P.	BRANCH	D. P.	BRANCH	D. P.
2	8.2915E+00	8	2.0794E+00				
FLOW THROUGH BLOWERS (CFM)							
BRANCH	FLOW	BRANCH	FLOW	BRANCH	FLOW	BRANCH	FLOW
2	-2.8480E+04	8	3.0407E+04				
PRESSURE DROP IN FILTERS (PSI)							
BRANCH	D. P.	BRANCH	D. P.	BRANCH	D. P.	BRANCH	D. P.
6	1.6699E+00						
FLOW THROUGH FILTERS (CFM)							
BRANCH	FLOW	BRANCH	FLOW	BRANCH	FLOW	BRANCH	FLOW
6	2.5323E+04						
PRESSURE DROP IN DAMPERS (PSI)							
BRANCH	D. P.	BRANCH	D. P.	BRANCH	D. P.	BRANCH	D. P.
1	1.2238E+01	3	1.7015E+00	7	2.6671E+00	9	1.4745E+01
FLOW THROUGH DAMPERS (CFM)							
BRANCH	FLOW	BRANCH	FLOW	BRANCH	FLOW	BRANCH	FLOW
1	-3.7959E+04	3	-2.6557E+04	7	2.7332E+04	9	3.3371E+04
PRESSURE DROP IN DUCTS (PSI)							
BRANCH	D. P.	BRANCH	D. P.	BRANCH	D. P.	BRANCH	D. P.
4	2.3235E-01	5	8.3705E-01				
FLOW THROUGH DUCTS (CFM)							
BRANCH	FLOW	BRANCH	FLOW	BRANCH	FLOW	BRANCH	FLOW
4	1.0133E+04	5	1.7564E+04				

TABLE XII
 SUMMARY OF EXTREME VALUES AT TIME = 5.0000E-01 (S)

•	•	•	•	•	•	•	•	•	•
•	HIGHEST	PRESSURE	OF	22.23 (PSIG)	OCCURS	AT	NODE	4	
•	•	LOWEST	PRESSURE	OF	0.00 (PSIG)	OCCURS	AT	NODE	10
•	•	HIGHEST	TEMPERATURE	OF	1565.22 (F)	OCCURS	AT	NODE	4
•	•	LOWEST	TEMPERATURE	OF	60.00 (F)	OCCURS	AT	NODE	10
•	•	HIGHEST	VOLUME FLOW	OF	3.7959E+04 (CFM)	OCCURS	IN	BRANCH	1
•	•	LOWEST	VOLUME FLOW	OF	1.0133E+04 (CFM)	OCCURS	IN	BRANCH	4
•	•	HIGHEST	MASS FLOW	OF	3.7508E+01 (LB/S)	OCCURS	IN	BRANCH	9
•	•	LOWEST	MASS FLOW	OF	8.3221E+00 (LB/S)	OCCURS	IN	BRANCH	4
•	•	LARGEST	PRESSURE DIFFERENTIAL	OF	8.2915E+00 (PSI)	OCCURS	IN	BLOWER BRANCH	2
•	•	LARGEST	VOLUME FLOW	OF	3.0407E+04 (CFM)	OCCURS	IN	BLOWER BRANCH	8
•	•	LARGEST	PRESSURE DIFFERENTIAL	OF	1.6699E+00 (PSI)	OCCURS	IN	FILTER BRANCH	6
•	•	LARGEST	VOLUME FLOW	OF	2.5323E+04 (CFM)	OCCURS	IN	FILTER BRANCH	6
•	•	LARGEST	PRESSURE DIFFERENTIAL	OF	1.4745E+01 (PSI)	OCCURS	IN	DAMPER BRANCH	9
•	•	LARGEST	VOLUME FLOW	OF	-3.7959E+04 (CFM)	OCCURS	IN	DAMPER BRANCH	1
•	•	LARGEST	PRESSURE DIFFERENTIAL	OF	8.3705E-01 (PSI)	OCCURS	IN	DUCT BRANCH	5
•	•	LARGEST	VOLUME FLOW	OF	1.7564E+04 (CFM)	OCCURS	IN	DUCT BRANCH	5

TABLE X
 ARCHIVAL LIST OF PRESSURES, TEMPERATURES
 VOLUME FLOWS, AND MASS FLOWS

TIME = 7.5000E-01 (S)

		NODAL PRESSURES (PSIG)									
		0	1	2	3	4	5	6	7	8	9
0		0.	7.487E+00	1.442E+01	1.547E+01	1.527E+01	1.465E+01	1.308E+01	1.126E+01	9.372E+00	
10	0.										
		NODAL TEMPERATURES (F)									
		0	1	2	3	4	5	6	7	8	9
0		6.000E+01	1.452E+03	1.452E+03	1.452E+03	1.147E+03	8.143E+02	7.950E+02	7.783E+02	7.626E+02	
10	6.000E+01										
		BRANCH VOLUME FLOWS (CFM)									
		0	1	2	3	4	5	6	7	8	9
0		-3.181E+04	-2.378E+04	-2.240E+04	1.014E+04	1.669E+04	2.341E+04	2.539E+04	2.776E+04	3.054E+04	
		BRANCH MASS FLOWS (LB/S)									
		0	1	2	3	4	5	6	7	8	9
0		-1.662E+01	-1.632E+01	-1.591E+01	7.208E+00	1.402E+01	2.429E+01	2.531E+01	2.622E+01	2.709E+01	

TABLE XI
 ARCHIVAL LIST OF PRESSURE DIFFERENTIALS AND VOLUME FLOWS
 TIME = 7.5000E-01 (S)

PRESSURE DIFFERENTIAL IN BLOWERS (PSI)							
BRANCH	D. P.	BRANCH	D. P.	BRANCH	D. P.	BRANCH	D. P.
2	6.9354E+00	8	1.8884E+00				
FLOW THROUGH BLOWERS (CFM)							
BRANCH	FLOW	BRANCH	FLOW	BRANCH	FLOW	BRANCH	FLOW
2	-2.3783E+04	8	2.7760E+04				
PRESSURE DROP IN FILTERS (PSI)							
BRANCH	D. P.	BRANCH	D. P.	BRANCH	D. P.	BRANCH	D. P.
6	1.5691E+00						
FLOW THROUGH FILTERS (CFM)							
BRANCH	FLOW	BRANCH	FLOW	BRANCH	FLOW	BRANCH	FLOW
6	2.3409E+04						
PRESSURE DROP IN DAMPERS (PSI)							
BRANCH	D. P.	BRANCH	D. P.	BRANCH	D. P.	BRANCH	D. P.
1	7.4874E+00	3	1.0472E+00	7	1.8176E+00	9	9.3717E+00
FLOW THROUGH DAMPERS (CFM)							
BRANCH	FLOW	BRANCH	FLOW	BRANCH	FLOW	BRANCH	FLOW
1	-3.1807E+04	3	-2.2396E+04	7	2.5387E+04	9	3.0542E+04
PRESSURE DROP IN DUCTS (PSI)							
BRANCH	D. P.	BRANCH	D. P.	BRANCH	D. P.	BRANCH	D. P.
4	1.9999E-01	5	6.2329E-01				
FLOW THROUGH DUCTS (CFM)							
BRANCH	FLOW	BRANCH	FLOW	BRANCH	FLOW	BRANCH	FLOW
4	1.0140E+04	5	1.6692E+04				

TABLE XII
 SUMMARY OF EXTREME VALUES AT TIME = 7.5000E-01 (S)

•	•	•	•	•	•	•	•	•	•
•	HIGHEST PRESSURE OF	15.47 (PSIG)	OCCURS AT NODE	4					
•	LOWEST PRESSURE OF	0.00 (PSIG)	OCCURS AT NODE	10					
•	HIGHEST TEMPERATURE OF	1452.25 (F)	OCCURS AT NODE	2					
•	LOWEST TEMPERATURE OF	60.00 (F)	OCCURS AT NODE	10					
•	HIGHEST VOLUME FLOW OF	3.1807E+04 (CFM)	OCCURS IN BRANCH	1					
•	LOWEST VOLUME FLOW OF	1.0140E+04 (CFM)	OCCURS IN BRANCH	4					
•	HIGHEST MASS FLOW OF	2.7091E+01 (LB/S)	OCCURS IN BRANCH	9					
•	LOWEST MASS FLOW OF	7.2082E+00 (LB/S)	OCCURS IN BRANCH	4					
•	LARGEST PRESSURE DIFFERENTIAL OF	6.9354E+00 (PSI)	OCCURS IN BLOWER BRANCH	2					
•	LARGEST VOLUME FLOW OF	2.7760E+04 (CFM)	OCCURS IN BLOWER BRANCH	8					
•	LARGEST PRESSURE DIFFERENTIAL OF	1.5691E+00 (PSI)	OCCURS IN FILTER BRANCH	6					
•	LARGEST VOLUME FLOW OF	2.3409E+04 (CFM)	OCCURS IN FILTER BRANCH	6					
•	LARGEST PRESSURE DIFFERENTIAL OF	9.3717E+00 (PSI)	OCCURS IN DAMPER BRANCH	9					
•	LARGEST VOLUME FLOW OF	-3.1807E+04 (CFM)	OCCURS IN DAMPER BRANCH	1					
•	LARGEST PRESSURE DIFFERENTIAL OF	6.2329E-01 (PSI)	OCCURS IN DUCT BRANCH	5					
•	LARGEST VOLUME FLOW OF	1.6692E+04 (CFM)	OCCURS IN DUCT BRANCH	5					

TABLE X
 ARCHIVAL LIST OF PRESSURES, TEMPERATURES
 VOLUME FLOWS, AND MASS FLOWS

TIME = 1.0000E+00 (S)

NODAL PRESSURES (PSIG)

	0	1	2	3	4	5	6	7	8	9
0										
10 0.	0.	4.344E+00	9.995E+00	1.062E+01	1.047E+01	1.004E+01	8.645E+00	7.479E+00	5.859E+00	

NODAL TEMPERATURES (F)

	0	1	2	3	4	5	6	7	8	9
0										
10 6.000E+01	6.000E+01	1.361E+03	1.359E+03	1.358E+03	1.115E+03	8.345E+02	8.176E+02	8.029E+02	7.894E+02	

BRANCH VOLUME FLOWS (CFM)

	0	1	2	3	4	5	6	7	8	9
0										
0		-2.552E+04	-1.933E+04	-1.837E+04	9.405E+03	1.498E+04	2.061E+04	2.238E+04	2.404E+04	2.642E+04

BRANCH MASS FLOWS (LB/S)

	0	1	2	3	4	5	6	7	8	9
0										
0		-1.202E+01	-1.183E+01	-1.151E+01	5.898E+00	1.078E+01	1.774E+01	1.842E+01	1.902E+01	1.958E+01

TABLE XI
 ARCHIVAL LIST OF PRESSURE DIFFERENTIALS AND VOLUME FLOWS
 TIME = 1.0000E+00 (S)

PRESSURE DIFFERENTIAL IN BLOWERS (PSI)							
BRANCH	D. P.	BRANCH	D. P.	BRANCH	D. P.	BRANCH	D. P.
2	5.6510E+00	8	1.6202E+00				
FLOW THROUGH BLOWERS (CFM)							
BRANCH	FLOW	BRANCH	FLOW	BRANCH	FLOW	BRANCH	FLOW
2	-1.9335E+04	8	2.4044E+04				
PRESSURE DROP IN FILTERS (PSI)							
BRANCH	D. P.	BRANCH	D. P.	BRANCH	D. P.	BRANCH	D. P.
6	1.3951E+00						
FLOW THROUGH FILTERS (CFM)							
BRANCH	FLOW	BRANCH	FLOW	BRANCH	FLOW	BRANCH	FLOW
6	2.0606E+04						
PRESSURE DROP IN DAMPERS (PSI)							
BRANCH	D. P.	BRANCH	D. P.	BRANCH	D. P.	BRANCH	D. P.
1	4.3442E+00	3	6.2127E-01	7	1.1659E+00	9	5.8590E+00
FLOW THROUGH DAMPERS (CFM)							
BRANCH	FLOW	BRANCH	FLOW	BRANCH	FLOW	BRANCH	FLOW
1	-2.5520E+04	3	-1.8367E+04	7	2.2380E+04	9	2.6416E+04
PRESSURE DROP IN DUCTS (PSI)							
BRANCH	D. P.	BRANCH	D. P.	BRANCH	D. P.	BRANCH	D. P.
4	1.5007E-01	5	4.2625E-01				
FLOW THROUGH DUCTS (CFM)							
BRANCH	FLOW	BRANCH	FLOW	BRANCH	FLOW	BRANCH	FLOW
4	9.4054E+03	5	1.4976E+04				

TABLE XII
 SUMMARY OF EXTREME VALUES AT TIME = 1.0000E+00 (S)

•	•	•	•	•	•	•	•	•	•
•	HIGHEST PRESSURE OF	10.62 (PSIG)	OCCURS AT NODE	4					
•	LOWEST PRESSURE OF	0.00 (PSIG)	OCCURS AT NODE	10					
•	HIGHEST TEMPERATURE OF	1360.95 (F)	OCCURS AT NODE	2					
•	LOWEST TEMPERATURE OF	60.00 (F)	OCCURS AT NODE	10					
•	HIGHEST VOLUME FLOW OF	2.6416E+04 (CFM)	OCCURS IN BRANCH	9					
•	LARGEST VOLUME FLOW OF	9.4054E+03 (CFM)	OCCURS IN BRANCH	4					
•	HIGHEST MASS FLOW OF	1.9583E+01 (LB/S)	OCCURS IN BRANCH	9					
•	LOWEST MASS FLOW OF	5.8985E+00 (LB/S)	OCCURS IN BRANCH	4					
•	LARGEST PRESSURE DIFFERENTIAL OF	5.6510E+00 (PSI)	OCCURS IN BLOWER BRANCH	2					
•	LARGEST VOLUME FLOW OF	2.4044E+04 (CFM)	OCCURS IN BLOWER BRANCH	8					
•	LARGEST PRESSURE DIFFERENTIAL OF	1.3951E+00 (PSI)	OCCURS IN FILTER BRANCH	6					
•	LARGEST VOLUME FLOW OF	2.0606E+04 (CFM)	OCCURS IN FILTER BRANCH	6					
•	LARGEST PRESSURE DIFFERENTIAL OF	5.8590E+00 (PSI)	OCCURS IN DAMPER BRANCH	9					
•	LARGEST VOLUME FLOW OF	2.6416E+04 (CFM)	OCCURS IN DAMPER BRANCH	9					
•	LARGEST PRESSURE DIFFERENTIAL OF	4.2625E-01 (PSI)	OCCURS IN DUCT BRANCH	5					
•	LARGEST VOLUME FLOW OF	1.4976E+04 (CFM)	OCCURS IN DUCT BRANCH	5					

TABLE XIII
SUMMARY OF EXTREME VALUES FOR THE ENTIRE PROBLEM

```

* * * * *
*   MAXIMUM PRESSURE OF 57.77 (PSIG) OCCURS AT NODE 4 AT TIME= .00950 (S)
*   MINIMUM PRESSURE OF -.02 (PSIG) OCCURS AT NODE 2 AT TIME= 0.00000 (S)
*   MAXIMUM TEMPERATURE OF 1995.14 (F) OCCURS AT NODE 4 AT TIME= .00950 (S)
*   MINIMUM TEMPERATURE OF 60.00 (F) OCCURS AT NODE 6 AT TIME= .00050 (S)
*   MAXIMUM VOLUME FLOW OF 9.1160E+04 (CFM) OCCURS IN BRANCH 4 AT TIME= .01250 (S)
*   MINIMUM VOLUME FLOW OF 8.7109E+01 (CFM) OCCURS IN BRANCH 1 AT TIME= .00300 (S)
*   MAXIMUM MASS FLOW OF 1.1931E+02 (LB/S) OCCURS IN BRANCH 3 AT TIME= .00900 (S)
*   MINIMUM MASS FLOW OF 1.1155E-01 (LB/S) OCCURS IN BRANCH 1 AT TIME= .00300 (S)
*   MAXIMUM BLOWER PRESSURE DIFFERENTIAL OF 1.9698E+01 (PSIG) OCCURS IN BRANCH 2 AT TIME= .01050 (S)
*   MAXIMUM BLOWER VOLUME FLOW OF 6.7984E+04 (CFM) OCCURS IN BRANCH 2 AT TIME= .01050 (S)
*   MAXIMUM FILTER PRESSURE DIFFERENTIAL OF 1.8247E+00 (PSIG) OCCURS IN BRANCH 6 AT TIME= .12900 (S)
*   MAXIMUM FILTER VOLUME FLOW OF 3.3633E+04 (CFM) OCCURS IN BRANCH 6 AT TIME= .09050 (S)
*   MAXIMUM DAMPER PRESSURE DIFFERENTIAL OF 4.1396E+01 (PSIG) OCCURS IN BRANCH 1 AT TIME= .03450 (S)
*   MAXIMUM DAMPER VOLUME FLOW OF 9.0767E+04 (CFM) OCCURS IN BRANCH 3 AT TIME= .00900 (S)
*   MAXIMUM DUCT PRESSURE DIFFERENTIAL OF 5.5976E+01 (PSIG) OCCURS IN BRANCH 4 AT TIME= .00950 (S)
*   MAXIMUM DUCT VOLUME FLOW OF 9.1160E+04 (CFM) OCCURS IN BRANCH 4 AT TIME= .01250 (S)

```

EXPLOSION IN LARGE ROOM, NODE 4

***** SELECTED PLOT DATA *****

```

NO. OF PRESSURE FRAMES      = 2
NO. OF TEMPERATURE FRAMES  = 2
NO. OF VOLUME FLOW FRAMES  = 3
NO. OF MASS FLOW FRAMES    = 1
NO. OF DIF. PRES. FRAMES   = 1
** FRAME 1 PRESSURE (PSIG)   NODE NOS. = 2 3 4 5
** FRAME 2 PRESSURE (PSIG)   NODE NOS. = 6 7 8 9
** FRAME 3 TEMPERATURE (F)   NODE NOS. = 2 3 4 5
** FRAME 4 TEMPERATURE (F)   NODE NOS. = 6 7 8 9
** FRAME 5 VOLUME FLOW (CFM)  BRANCH NOS. = 1 2 3
** FRAME 6 VOLUME FLOW (CFM)  BRANCH NOS. = 4 5 6
** FRAME 7 VOLUME FLOW (CFM)  BRANCH NOS. = 7 8 9
** FRAME 8 MASS FLOW (LB/S)   BRANCH NOS. = 3 4 5
** FRAME 9 PRESSURE DIFF. (PSI) BRANCH NOS. = 6

```

EXPLOSION IN LARGE ROOM, NODE 4

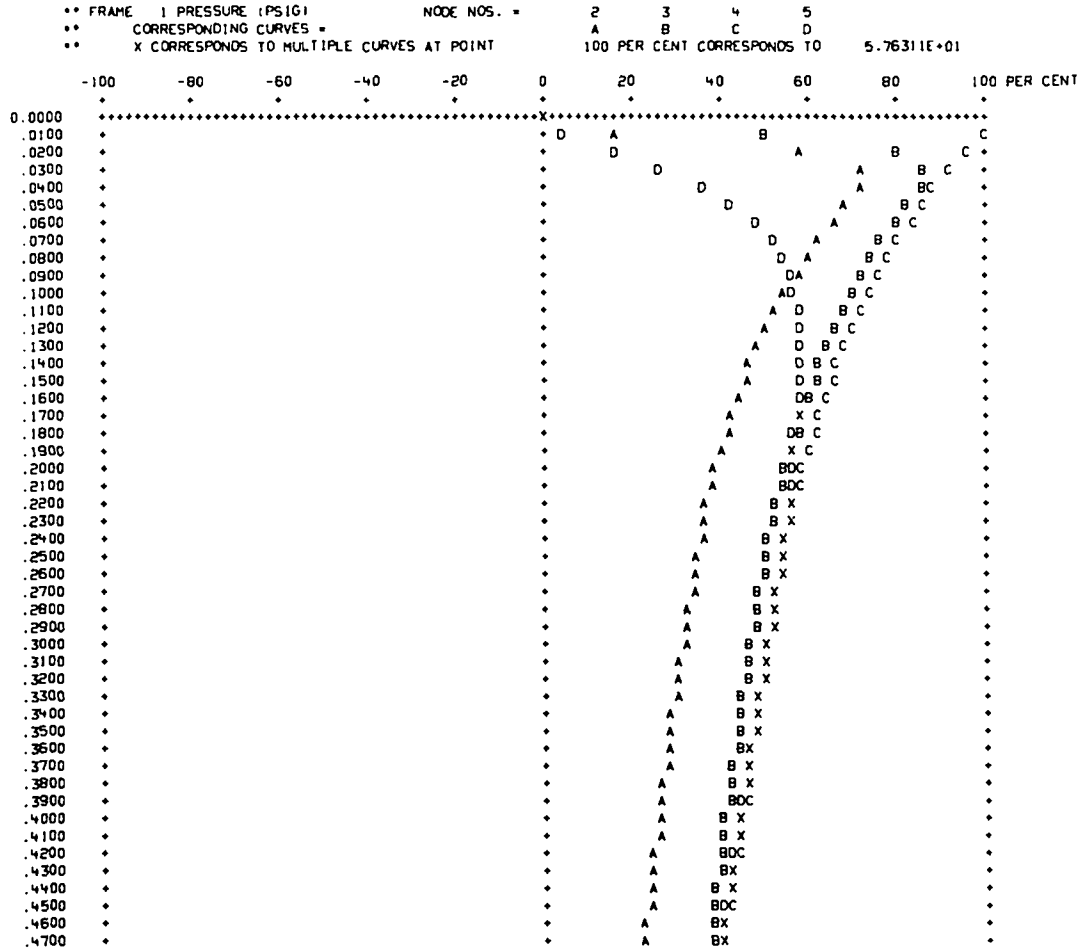

```

.4800 *
.4900 *
.5000 *
.5100 *
.5200 *
.5300 *
.5400 *
.5500 *
.5600 *
.5700 *
.5800 *
.5900 *
.6000 *
.6100 *
.6200 *
.6300 *
.6400 *
.6500 *
.6600 *
.6700 *
.6800 *
.6900 *
.7000 *
.7100 *
.7200 *
.7300 *
.7400 *
.7500 *
.7600 *
.7700 *
.7800 *
.7900 *
.8000 *
.8100 *
.8200 *
.8300 *
.8400 *
.8500 *
.8600 *
.8700 *
.8800 *
.8900 *
.9000 *
.9100 *
.9200 *
.9300 *
.9400 *
.9500 *
.9600 *
.9700 *
.9800 *
.9900 *
1.0000 *
TIME(S)

```

Time (s)	A	B	X	BOC
.4800				
.4900				
.5000				
.5100				
.5200				
.5300				
.5400				
.5500				
.5600				
.5700				
.5800				
.5900				
.6000				
.6100				
.6200				
.6300				
.6400				
.6500				
.6600				
.6700				
.6800				
.6900				
.7000				
.7100				
.7200				
.7300				
.7400				
.7500				
.7600				
.7700				
.7800				
.7900				
.8000				
.8100				
.8200				
.8300				
.8400				
.8500				
.8600				
.8700				
.8800				
.8900				
.9000				
.9100				
.9200				
.9300				
.9400				
.9500				
.9600				
.9700				
.9800				
.9900				
1.0000				

EXPLOSION IN LARGE ROOM, NODE 4

** FRAME 2 PRESSURE (PSIG) NODE NOS. = 6 7 8 9
 ** CORRESPONDING CURVES = A B C D
 ** X CORRESPONDS TO MULTIPLE CURVES AT POINT 100 PER CENT CORRESPONDS TO 3.02596E+01

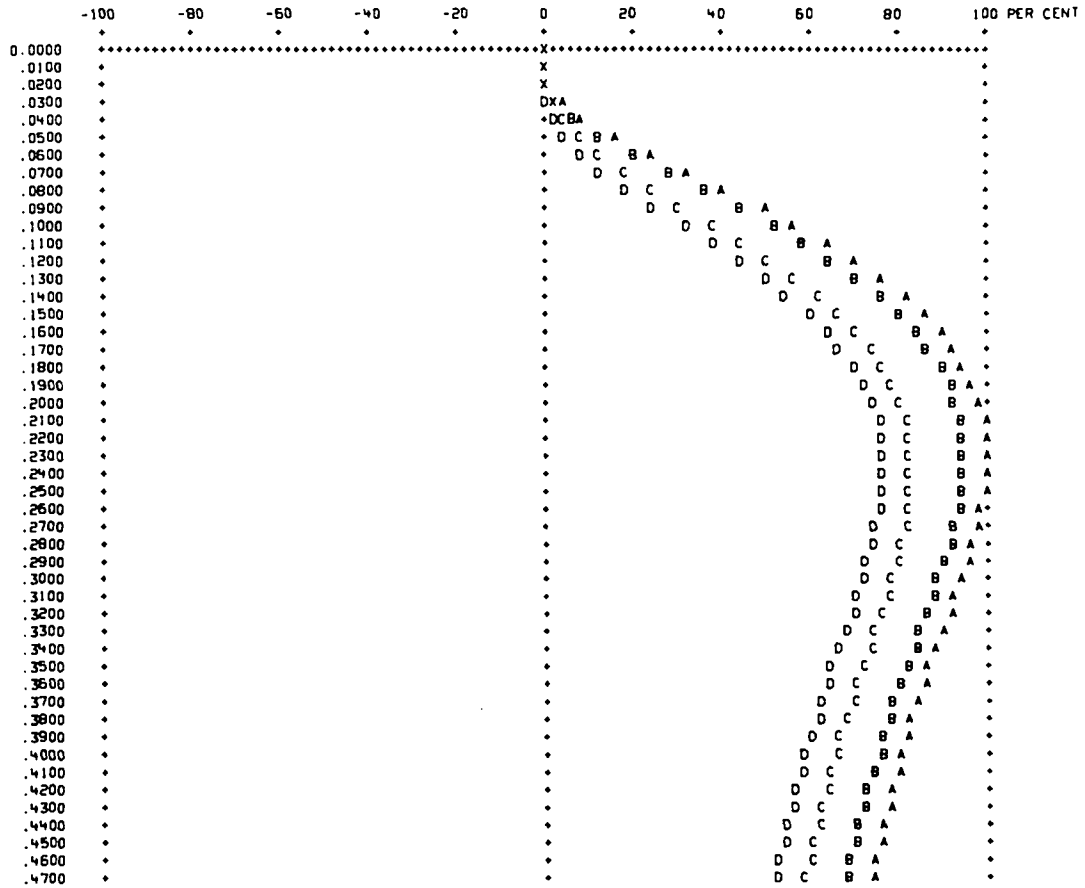

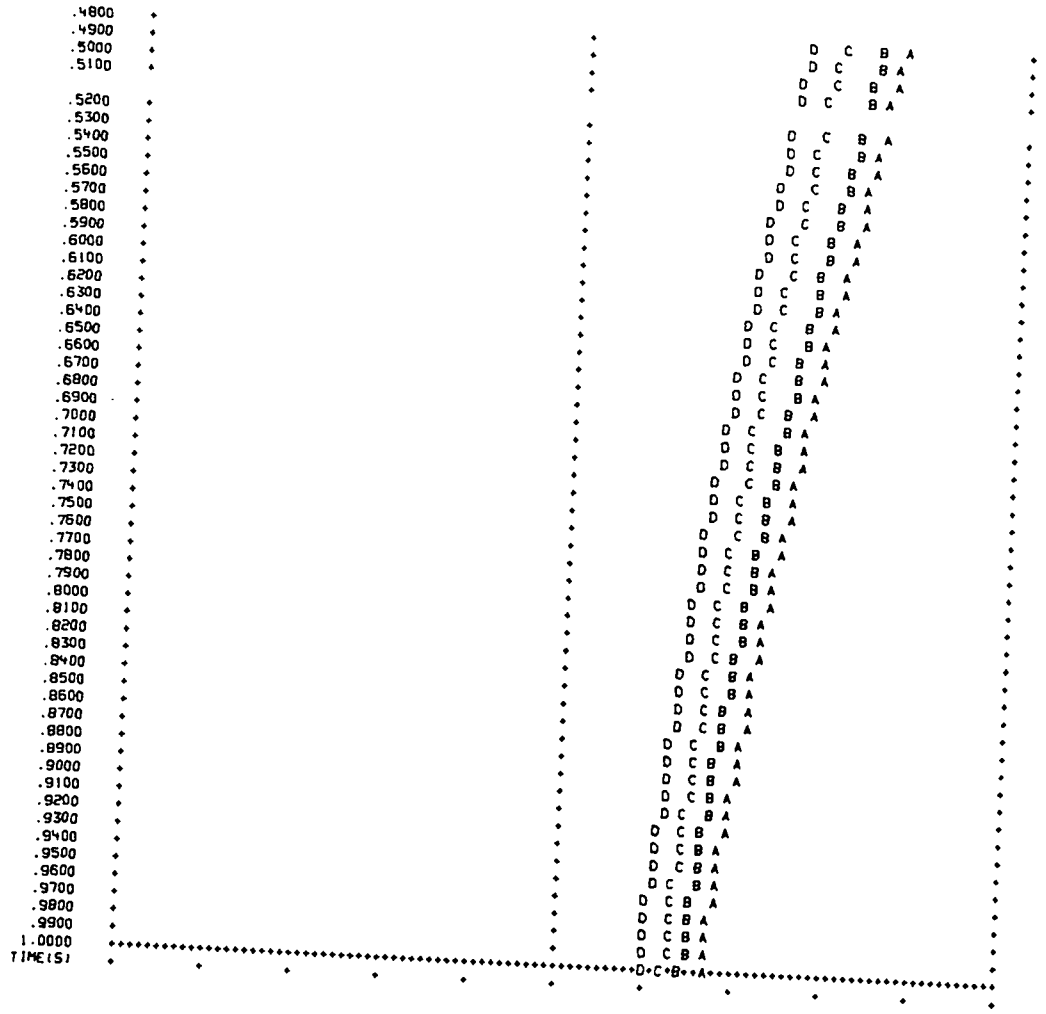

EXPLOSION IN LARGE ROOM, NODE 4

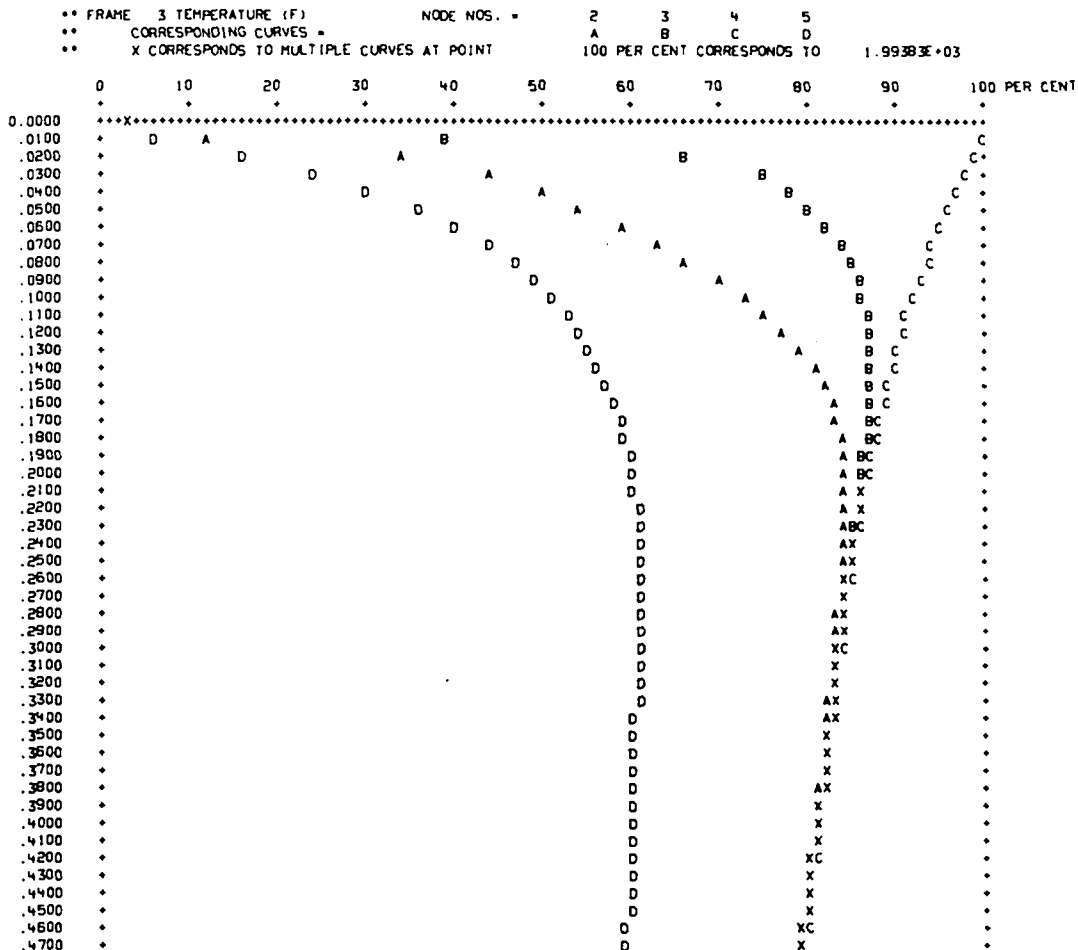

EXPLOSION IN LARGE ROOM, NODE 4

** FRAME 4 TEMPERATURE (F) NODE NOS. = 6 7 8 9
 ** CORRESPONDING CURVES = A B C D
 ** X CORRESPONDS TO MULTIPLE CURVES AT POINT 100 PER CENT CORRESPONDS TO 8.34459E+02

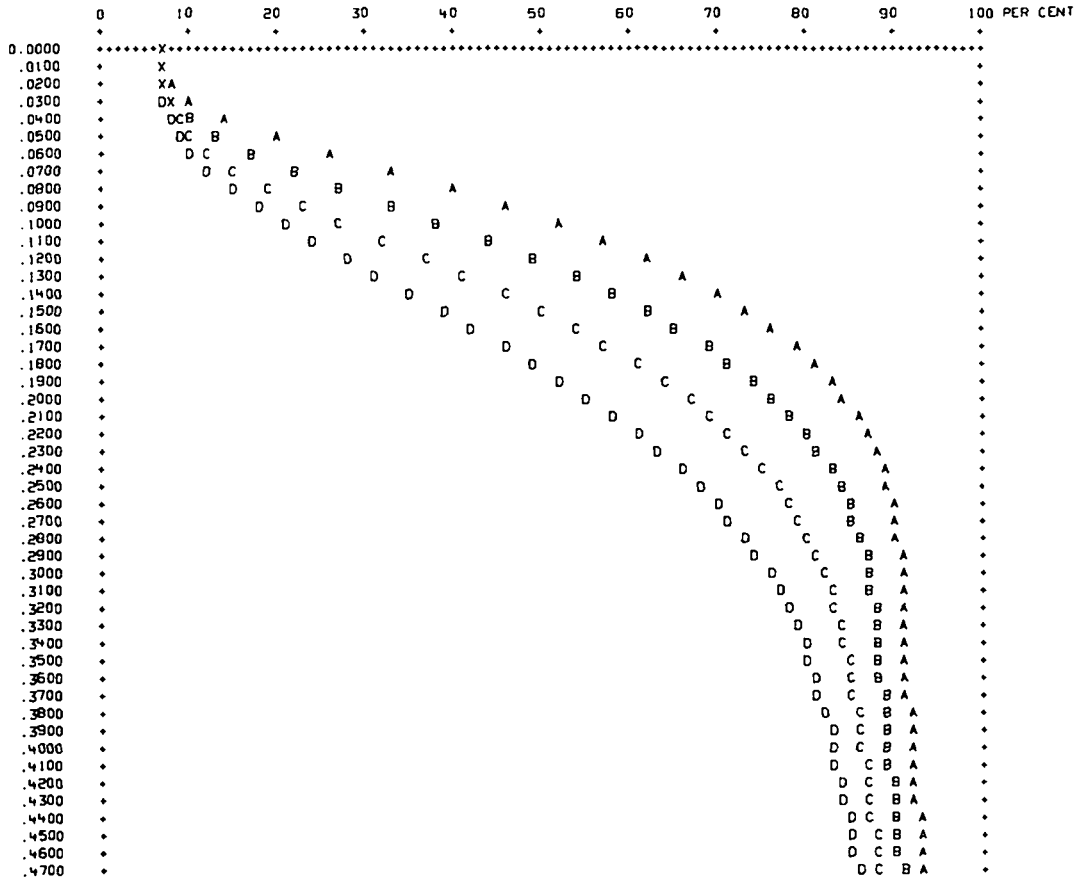

EXPLOSION IN LARGE ROOM, NODE 4

** FRAME 5 VOLUME FLOW (CFM) BRANCH NOS. = 1 2 3
 ** CORRESPONDING CURVES = A B C
 ** X CORRESPONDS TO MULTIPLE CURVES AT POINT 100 PER CENT CORRESPONDS TO 8.66038E+04

	-100	-80	-60	-40	-20	0	20	40	60	80	100 PER CENT
0.0000	+	+	+	+	+	X	+	+	+	+	+
.0100	C	B			A						
.0200			C B								
.0300					A						
.0400					XC						
.0500					A B C						
.0600					A B C						
.0700					A BC						
.0800					A B C						
.0900					A B C						
.1000					A BC						
.1100					A B C						
.1200					A B C						
.1300					A B C						
.1400					A B C						
.1500					A B C						
.1600					A B C						
.1700					A B C						
.1800					A B C						
.1900					A BC						
.2000					A BC						
.2100					A BC						
.2200					A BC						
.2300					A BC						
.2400					A BC						
.2500					A BC						
.2600					A BC						
.2700					A BC						
.2800					A BC						
.2900					A BC						
.3000					A BC						
.3100					A B C						
.3200					A B C						
.3300					A B C						
.3400					A B C						
.3500					A B C						
.3600					A B C						
.3700					A BC						
.3800					A BC						
.3900					A BC						
.4000					A BC						
.4100					A BC						
.4200					A BC						
.4300					A BC						
.4400					A BC						
.4500					A BC						
.4600					A BC						
.4700					A BC						

.4800	*			
.4900	*	A	BC	
.5000	*	A	B C	
.5100	*	A	BC	
		A	BC	
.5200	*			
.5300	*	A	BC	
.5400	*	A	BC	
.5500	*	A	BC	
.5600	*	A	BC	
.5700	*	A	BC	
.5800	*	A	BC	
.5900	*	A	BC	
.6000	*	A	BC	
.6100	*	A	BC	
.6200	*	A	BC	
.6300	*	A	BC	
.6400	*	A	BC	
.6500	*	A	BC	
.6600	*	A	BC	
.6700	*	A	BC	
.6800	*	A	BC	
.6900	*	A	X	
.7000	*	A	BC	
.7100	*	A	BC	
.7200	*	A	BC	
.7300	*	A	BC	
.7400	*	A	BC	
.7500	*	A	BC	
.7600	*	A	BC	
.7700	*	A	BC	
.7800	*	A	BC	
.7900	*	A	X	
.8000	*	A	X	
.8100	*	A	BC	
.8200	*	A	BC	
.8300	*	A	BC	
.8400	*	A	BC	
.8500	*	A	BC	
.8600	*	A	BC	
.8700	*	A	BC	
.8800	*	A	X	
.8900	*	A	X	
.9000	*	A	X	
.9100	*	A	X	
.9200	*	A	BC	
.9300	*	A	BC	
.9400	*	A	BC	
.9500	*	A	BC	
.9600	*	A	BC	
.9700	*	A	BC	
.9800	*	A	X	
.9900	*	A	X	
1.0000	*	A	X	
TIME (S)	*	A	X	*

EXPLOSION IN LARGE ROOM, NODE 4

** FRAME 6 VOLUME FLOW (CFM) BRANCH NOS. = 4 5 6
 ** CORRESPONDING CURVES = A B C
 ** X CORRESPONDS TO MULTIPLE CURVES AT POINT 100 PER CENT CORRESPONDS TO 9.08204E+04

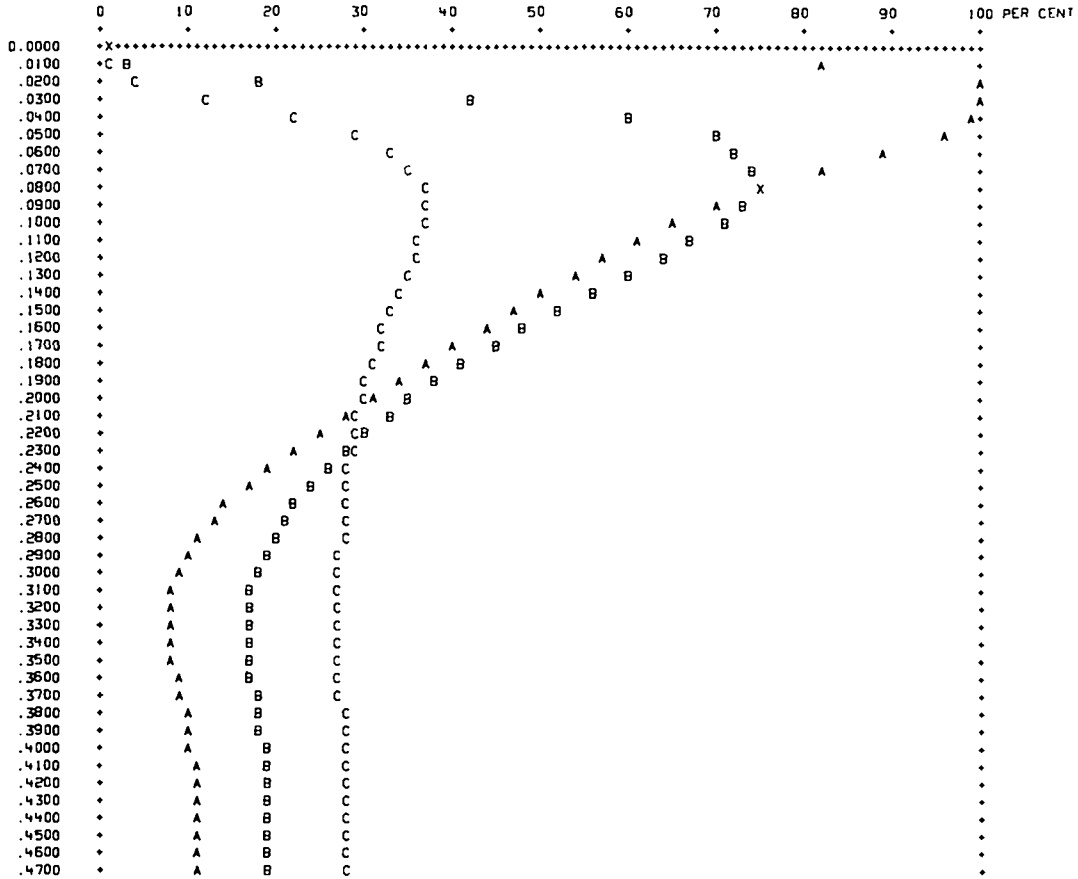

.4800	+	A	B	C	*
.4900	+	A	B	C	*
.5000	+	A	B	C	*
.5100	+	A	B	C	*
.5200	+	A	B	C	*
.5300	+	A	B	C	*
.5400	+	A	B	C	*
.5500	+	A	B	C	*
.5600	+	A	B	C	*
.5700	+	A	B	C	*
.5800	+	A	B	C	*
.5900	+	A	B	C	*
.6000	+	A	B	C	*
.6100	+	A	B	C	*
.6200	+	A	B	C	*
.6300	+	A	B	C	*
.6400	+	A	B	C	*
.6500	+	A	B	C	*
.6600	+	A	B	C	*
.6700	+	A	B	C	*
.6800	+	A	B	C	*
.6900	+	A	B	C	*
.7000	+	A	B	C	*
.7100	+	A	B	C	*
.7200	+	A	B	C	*
.7300	+	A	B	C	*
.7400	+	A	B	C	*
.7500	+	A	B	C	*
.7600	+	A	B	C	*
.7700	+	A	B	C	*
.7800	+	A	B	C	*
.7900	+	A	B	C	*
.8000	+	A	B	C	*
.8100	+	A	B	C	*
.8200	+	A	B	C	*
.8300	+	A	B	C	*
.8400	+	A	B	C	*
.8500	+	A	B	C	*
.8600	+	A	B	C	*
.8700	+	A	B	C	*
.8800	+	A	B	C	*
.8900	+	A	B	C	*
.9000	+	A	B	C	*
.9100	+	A	B	C	*
.9200	+	A	B	C	*
.9300	+	A	B	C	*
.9400	+	A	B	C	*
.9500	+	A	B	C	*
.9600	+	A	B	C	*
.9700	+	A	B	C	*
.9800	+	A	B	C	*
.9900	+	A	B	C	*
1.0000	+	A	B	C	*
TIME (S)	*	A	B	C	*

EXPLOSION IN LARGE ROOM, NODE 4

** FRAME 7 VOLUME FLOW (CFM) BRANCH NOS. = 7 8 9
 ** CORRESPONDING CURVES = A B C
 ** X CORRESPONDS TO MULTIPLE CURVES AT POINT 100 PER CENT CORRESPONDS TO 3.34674E+04

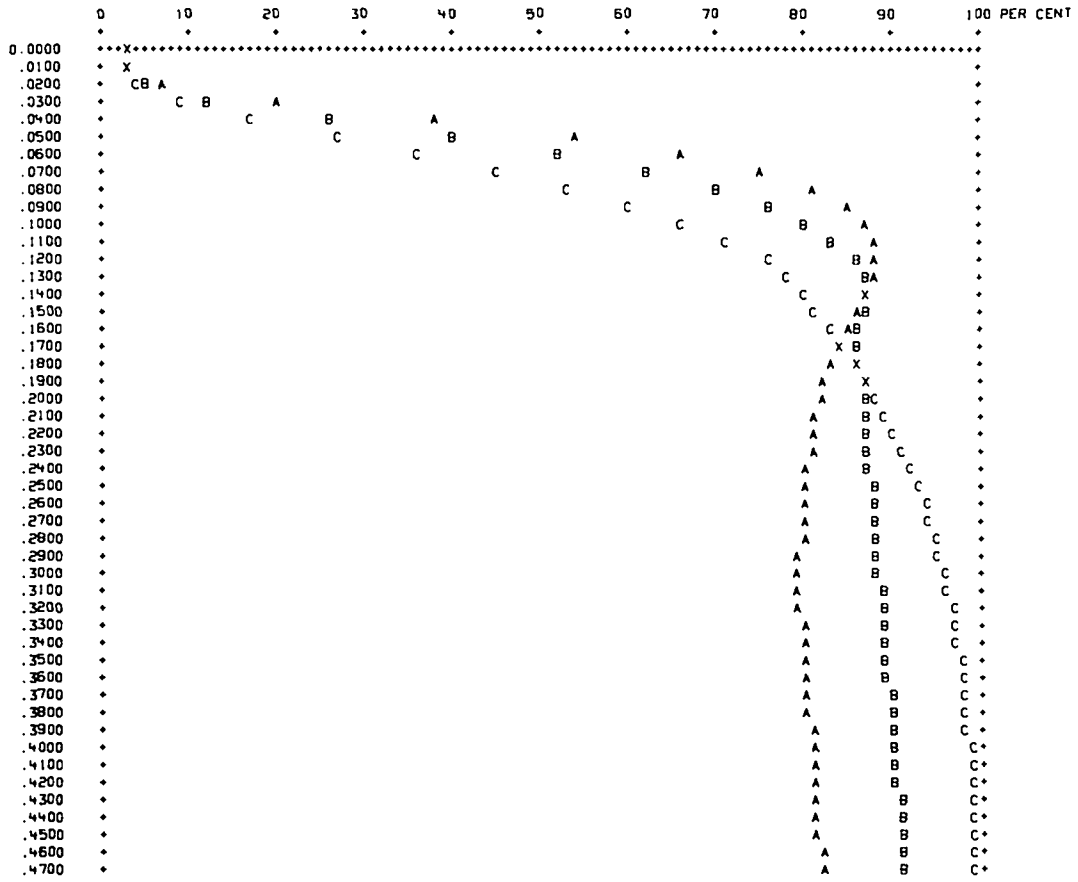

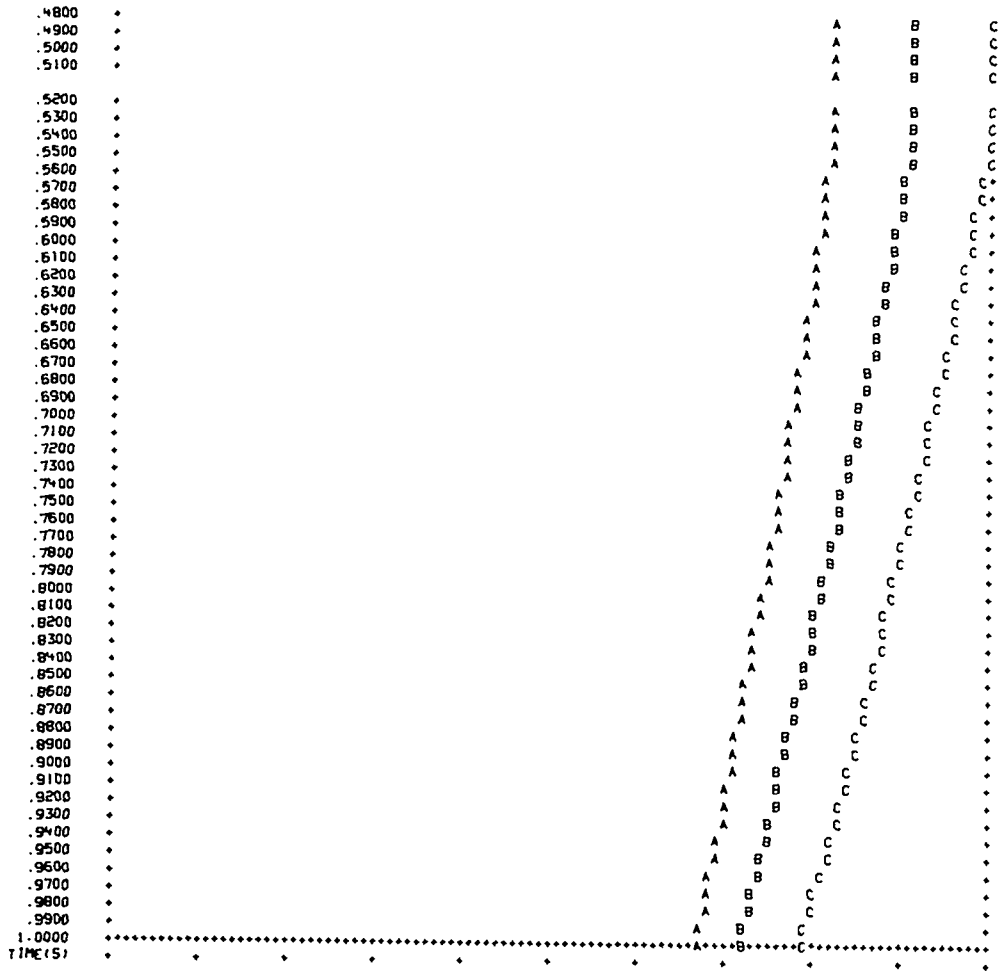

EXPLOSION IN LARGE ROOM, NODE 4

** FRAME B MASS FLOW (LB/S) BRANCH NOS. = 3 4 5
 ** CORRESPONDING CURVES = A B C
 ** X CORRESPONDS TO MULTIPLE CURVES AT POINT 100 PER CENT CORRESPONDS TO 1.16122E+02

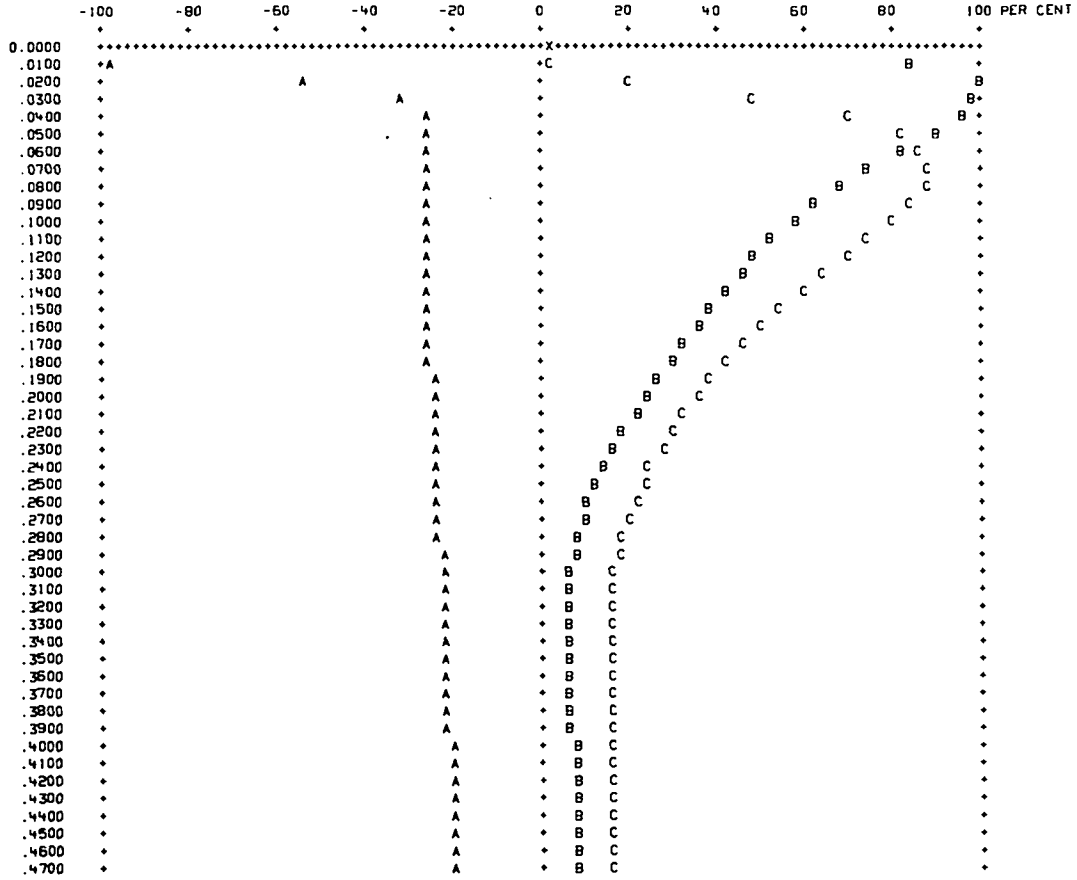

EXPLOSION IN LARGE ROOM, NODE 4

** FRAME 9 PRESSURE DIFF. (PSI) BRANCH NOS. = 6
 ** CORRESPONDING CURVES = A
 ** X CORRESPONDS TO MULTIPLE CURVES AT POINT 100 PER CENT CORRESPONDS TO 1.82457E+00

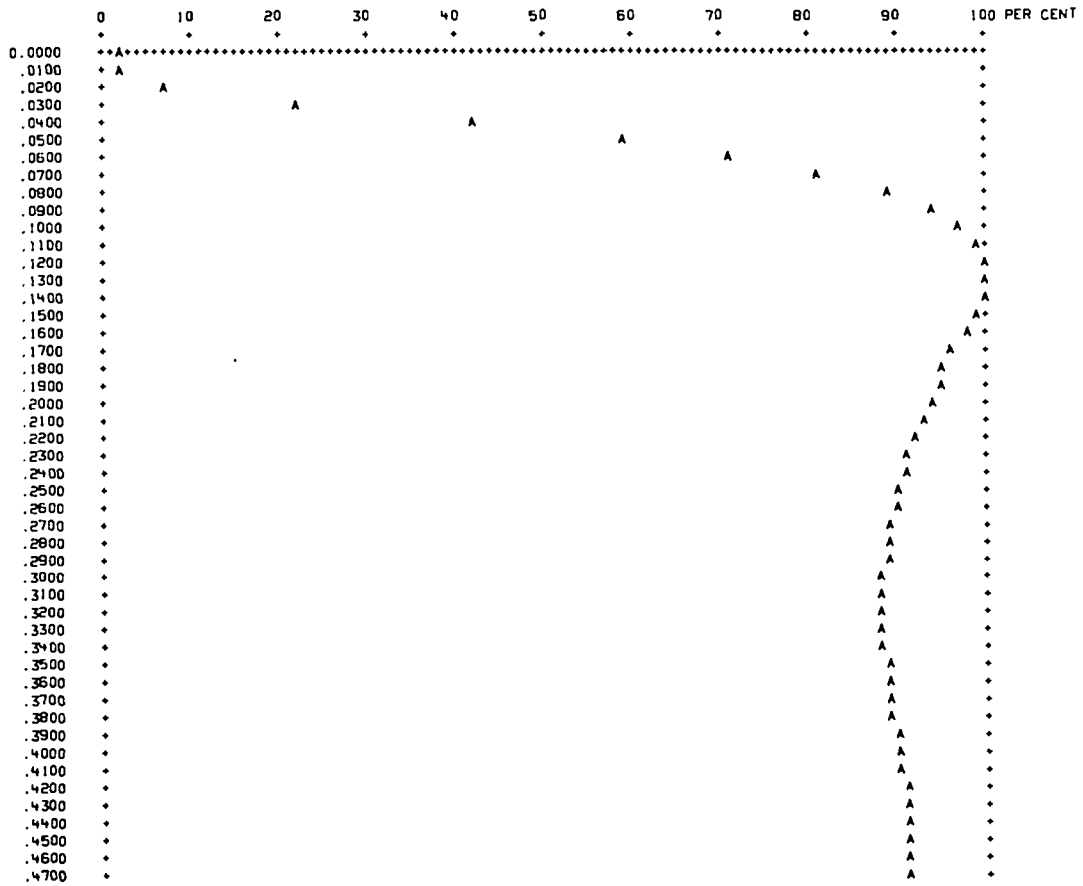

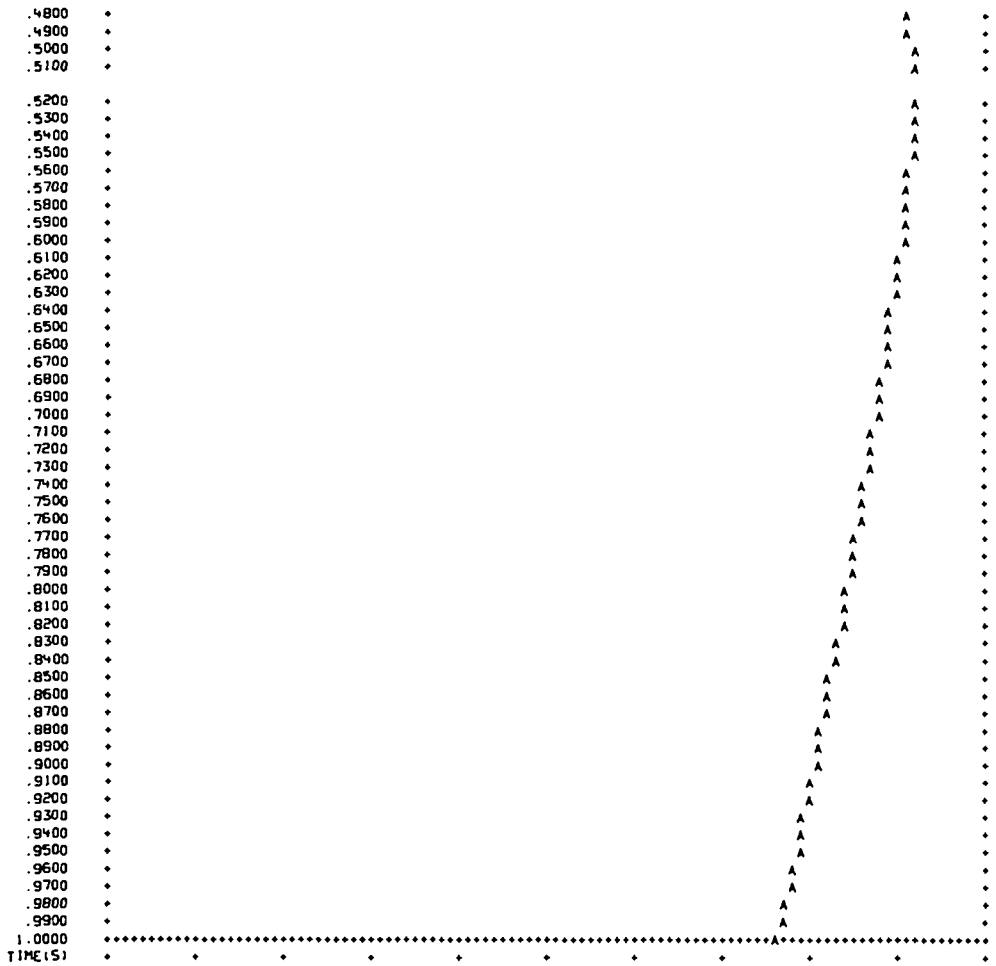

Printed in the United States of America
Available from
National Technical Information Service
US Department of Commerce
5285 Port Royal Road
Springfield, VA 22161

Microfiche (A01)

<u>Page Range</u>	<u>NTIS Price Code</u>	<u>Page Range</u>	<u>NTIS Price Code</u>	<u>Page Range</u>	<u>NTIS Price Code</u>	<u>Page Range</u>	<u>NTIS Price Code</u>
001-025	A02	151-175	A08	301-325	A14	451-475	A20
026-050	A03	176-200	A09	326-350	A15	476-500	A21
051-075	A04	201-225	A10	351-375	A16	501-525	A22
076-100	A05	226-250	A11	376-400	A17	526-550	A23
101-125	A06	251-275	A12	401-425	A18	551-575	A24
126-150	A07	276-300	A13	426-450	A19	576-600	A25
						601-up*	A99

*Contact NTIS for a price quote.